

# Series AXK

## Non-Rotating Piston Rod Type/Double Acting:Single Rod

Bore Size(mm) : Ø20, Ø25, Ø32, Ø40



- NUMEROUS MOUNTING OPTIONS
- MAGNET STANDARD FOR AUTO SWITCH
- BUMPERS STANDARD
- DESIGNED FOR NON-LUBRICATED SERVICE
- COMPACT LIGHT DESIGN
- REPLACEABLE ROD GLAND
- CUSTOM DESIGNED PISTON ROD FOR NON-ROTATION

Double Acting/Single Rod

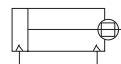

### How to Order

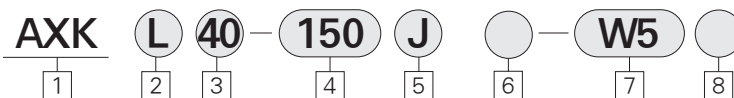

#### 1 Non-Rotating Piston Rod Type

※ Built-in Magnet Standard

#### 2 Mounting

B : Basic Type  
 L : Axial Foot Type  
 F : Rod Side Flange Type  
 G : Head Side Flange Type  
 C : Single Clevis Type  
 D : Double Clevis Type  
 T : Head Side Trunnion Type  
 U : Rod Side Trunnion Type  
 E : Integrated Clevis Type  
 BZ : Boss-Cut Basic Type  
 FZ : Boss-Cut Flange Type  
 UZ : Boss-Cut Trunnion Type

#### 3 Bore size(mm)

20 : Ø20  
 25 : Ø25  
 32 : Ø32  
 40 : Ø40

#### 4 Stroke (mm)

Ø20 : 25, 50, 75, 100, 125, 150, 200, 250, 300

Ø25 : 25, 50, 75, 100, 125, 150, 200, 250, 300  
 Ø32 : 25, 50, 75, 100, 125, 150, 200, 250, 300  
 Ø40 : 25, 50, 75, 100, 125, 150, 200, 250, 300

#### 5 Rod Boot Option

Blank : None  
 J : Nylon Tarpaulin  
 K : Neoprene Cloth

#### 6 Rod end thread type

Blank : Rod end male thread  
 F : Rod end female thread

#### 7 Auto Switch

(Band mounted type)  
 (Grommet)  
 Blank : None  
 W5 : Reed Switch, 0.5m Lead Wire  
 W5L : Reed Switch, 3m Lead Wire

#### 8 Number of Auto Switches

Blank : 2 pcs  
 S : 1 pc  
 N : N pcs

#### PART No. of Mounting Bracket

Bore size(mm)	Ø20	Ø25	Ø32	Ø40
※ Axial foot	TCM-L020B	TCM-L032B	TCM-L040B	
Flange	TCM-F020B	TCM-F032B	TCM-F040B	
Single clevis	TCM-C020B	TCM-C032B	TCM-C040B	
Double clevis	TCM-D020B	TCM-D032B	TCM-D040B	
Trunnion(With nut)	TCM-T020B	TCM-T032B	TCM-T040B	

※ 2 pcs. Required Per Cylinder

#### PART No. of Auto Switch Mounting Band

Auto Switch Model	Bore size(mm)			
	Ø20	Ø25	Ø32	Ø40
W5	TBM2-020	TBM2-025	TBM2-032	TBM2-040

ACP

APM

AS

AX

AM2

AM

AL  
ALX

AQ  
ADQ

AQ2  
ADQ2

AJ  
AJM

ABK

ACK1

NSK

AG

NGQ

AGX  
GX

NP

ADR

AMR

NDM

ARD

NST

AST

ASTH

NLCD

NLCS

## Series AXK

Model				
Bore Size(mm)	φ20	φ25	φ32	φ40
Action	Double Acting Single Rod			
Cushion	Rubber Cushion (Standard)			
Piping Method	Rc(PT) <sup>1</sup> / <sub>8</sub>	Rc(PT) <sup>1</sup> / <sub>8</sub>	Rc(PT) <sup>1</sup> / <sub>8</sub>	Rc(PT) <sup>1</sup> / <sub>4</sub>

Specifications					
Action	Double Acting Single Rod				
Fluid	Air				
Proof pressure	1.5 MPa (213psi)				
Max. Operating Pressure	1.0 MPa (140psi)				
Min. Operating Pressure	0.05 MPa (7psi)				
Ambient and Fluid Temperature	-10℃~+70℃ (14~ 158°F)				
Lubrication	None (Non-Lube)				
Stroke Tolerance	<sup>+1.4</sup> <sub>0</sub> mm				
Mounting	Basic Type, Axial Foot Type, Rod Side Flange Type, Head Side Flange Type, Single Clevis Type, Head Side Trunnion Type, Rod Side Trunnion Type, Integrated Clevis, Type Boss-Cut Type				
Non-Rotating Accuracy	<table border="1"> <tr> <td>φ20, φ25</td> <td>±0.8°</td> </tr> <tr> <td>φ32, φ40</td> <td>±0.5°</td> </tr> </table>	φ20, φ25	±0.8°	φ32, φ40	±0.5°
φ20, φ25	±0.8°				
φ32, φ40	±0.5°				

Piston Speed				
Bore Size(mm)	φ20	φ25	φ32	φ40
Piston Speed(mm/sec)	50 ~ 500			
Allowable Kinetic Energy(kgf/cm)	2.7	4	6.5	12

Auto Switch Specifications		
Mounting	Lead Wire Entry	Reed Switch
Band Mounting Type	Grommet	W5

Material of Boot		
Symbol	Material of Boot	Max. Ambient Temperature
J	Nylon Tarpaulin	60℃ (140°F)
K	Neoprene Cloth	※ 110℃ (230°F)

※ The max. ambient temperature of gaiters only.

## Series AXK

### Boss-Cut Type

Boss for the head cover bracket is eliminated and the total length of the cylinder is shortened.

#### Compared to the total length of cylinder (mm)

φ 20	φ 25	φ 32	φ 40
▼13	▼13	▼13	▼16

Mounting : ● Boss-Cut Basic Type(BZ)    ● Boss-Cut Flange Type(FZ)  
 ● Boss-Cut Trunnion Type(UZ)

ACP

APM

AS

AX

AM2

AM

AL  
ALXAQ  
ADQAQ2  
ADQ2AJ  
AJM

ABK

ACK1

NSK

AG

NGQ

AGX  
GX

NP

ADR

AMR

NDM

ARD

NST

AST

ASTH

NLCD

NLCS

### Mounting and Accessories

Accessories Mounting	Standard			Option		
	Mounting Nut	Rod End Nut	Clevis Pin	Knuckle Joint	Double Knuckle Joint	Boot
Basic Type	○ (1pc.)	○	—	○	○	○
Axial Foot Type	○ (2)	○	—	○	○	○
Rod Side Flange Type	○ (1)	○	—	○	○	○
Head Side Flange Type	○ (1)	○	—	○	○	○
Integrated Clevis Type	—	○	—	○	○	○
Single Clevis Type	—	○	—	○	○	○
Double Clevis Type	—	○	○	○	○	○
Head Side Trunnion Type	○ (1)	○	—	○	○	○
Rod Side Trunnion Type	○ (1)	○	—	○	○	○
Boss-Cut Basic Type	○ (1)	○	—	○	○	○
Boss-Cut Flange Type	○ (1)	○	—	○	○	○
Boss-Cut Trunnion Type	○ (1)	○	—	○	○	○
Note					With pin	

### Weight Table

kgf(lbf)

Bore Size(mm)		φ 20	φ 25	φ 32	φ 40
Basic weight	Basic Type	0.14(0.31)	0.21(0.46)	0.28(0.62)	0.58(1.26)
Mounting Bracket Weight	Axial Foot Type	0.29(0.64)	0.38(0.82)	0.44(0.97)	0.84(1.85)
	Flange Type	0.20(0.44)	0.30(0.66)	0.37(0.82)	0.69(1.52)
	Integrated Clevis Type	0.12(0.26)	0.19(0.42)	0.27(0.60)	0.53(1.17)
	Single Clevis Type	0.18(0.40)	0.26(0.55)	0.32(0.71)	0.66(1.46)
	Double Clevis Type	0.19(0.42)	0.27(0.60)	0.33(0.73)	0.70(1.54)
	Trunnion Type	0.18(0.40)	0.28(0.62)	0.34(0.75)	0.67(1.48)
	Boss-Cut Basic Type	0.13(0.29)	0.19(0.42)	0.26(0.57)	0.54(1.19)
	Boss-Cut Flange Type	0.19(0.42)	0.29(0.62)	0.35(0.77)	0.66(1.46)
	Boss-Cut Trunnion Type	0.17(0.37)	0.26(0.57)	0.32(0.71)	0.64(1.41)
Additional weight for each 50 mm of stroke		0.04(0.09)	0.08(0.15)	0.09(0.20)	0.14(0.31)
Accessories	Single Knuckle joint	0.06(0.13)	0.06(0.13)	0.06(0.13)	0.23(0.51)
Weight	Double Knuckle Joint (with pin)	0.08(0.15)	0.08(0.15)	0.08(0.15)	0.20(0.44)

### Calculation Example

AXKL 32-100

- Basic weight : 0.44(Foot type φ 32)
  - Additional weight : 0.09/50 stroke
  - Cylinder stroke : 100 stroke
- $$0.44 + 0.09 \times 100/50 = 0.62\text{kgf}$$

# Series AXK

## Construction / Parts List

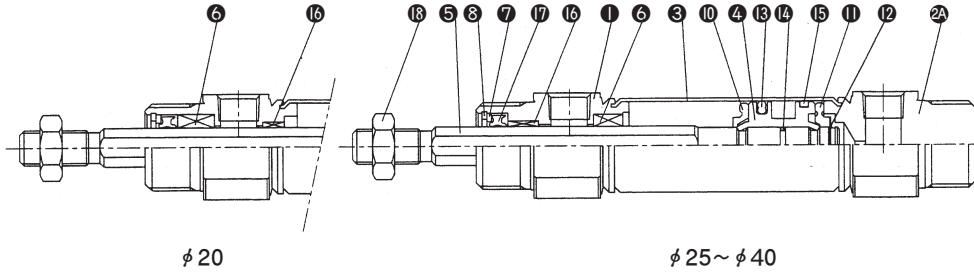

Boss-Cut Type

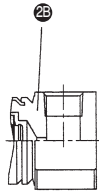

Integrated Clevis Type

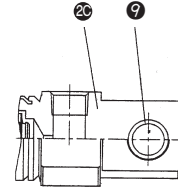

### Parts

No	Description	Material	Remarks
①	Rod Cover	Alluminum Alloy	White Alumite
2A	Head Cover-A	"	"
2B	Head Cover-B	"	"
2C	Head Cover-C	"	"
③	Cylinder Tube	stainless steel	-
④	Piston	Alluminum Alloy	Chromate
⑤	Pistan Rod	Stainless steel	
⑥	Guide Bush	Sintered Metal	
⑦	Retaining Ring	Rolled steel	Nickel Plated
⑧	Stopper Ring	Carbon Tool steel	"
⑨	Guide Bush	Sintered Metal	
⑩	DAMPER A	Urethane	
⑪	DAMPER B	"	

No	Description	Material	Remarks
⑫	Stopper Ring	Carbon Tool steel	
⑬	Piston Packing	NBR	
⑭	Piston Gasket	NBR	
⑮	Wear Ring	Resin	
⑯	Bush	Brass	
⑰	Rod End Nut		Nickel Plated

### Packing List

No	Description	Material	Bore Size (mm)			
			20	25	32	40
⑰	Rod Packing	NBR	SORA-10	SORA-10	SORA-12	SORA-16

Basic Type(B)

AXKB  Bore Size  Stroke

Standard Type

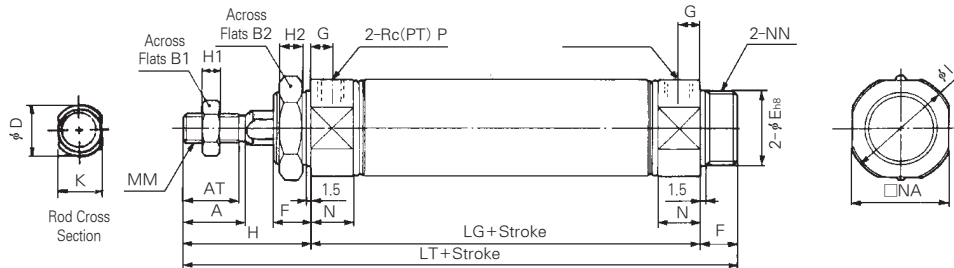

Boss-cut type

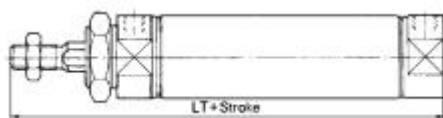

With Rod Boot

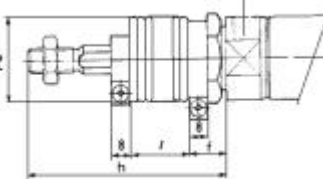

Rod end female thread type

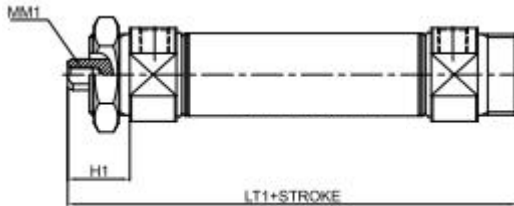

Bore Size	A	AT	B <sub>1</sub>	B <sub>2</sub>	D	E	F	G	H	H <sub>1</sub>	H <sub>2</sub>	I	K	MM	N	NA	NN	P	LG	LT
φ 20	18	15.5	13	26	10 <sup>-0.01/-0.05</sup>	20 <sup>0/-0.033</sup>	13	φ8	41	5	8	27	8 <sup>-0.01/-0.05</sup>	M8×1.25	15	24	M20×1.5	1/8	62	116
φ 25	22	19.5	17	32	10 <sup>-0.01/-0.05</sup>	26 <sup>0/-0.033</sup>	13	8	45	6	8	33	8 <sup>-0.01/-0.05</sup>	M8×1.25	15	30	M26×1.5	1/8	62	120
φ 32	22	19.5	17	32	12 <sup>-0.01/-0.05</sup>	26 <sup>0/-0.033</sup>	13	8	45	6	8	37.5	10 <sup>-0.01/-0.05</sup>	M10×1.25	15	34.5	M26×1.5	1/8	64	122
φ 40	24	21	22	41	16 <sup>-0.01/-0.05</sup>	32 <sup>0/-0.039</sup>	16	11	50	8	10	46.5	14 <sup>-0.01/-0.05</sup>	M14×1.5	21.5	42.5	M32×2	1/4	88	154

With Rod Boot (mm)

Bore Size	e	f	h					l				
			1~50 <sup>φ</sup>	51~100 <sup>φ</sup>	101~150 <sup>φ</sup>	151~200 <sup>φ</sup>	201~300 <sup>φ</sup>	1~50 <sup>φ</sup>	51~100 <sup>φ</sup>	101~150 <sup>φ</sup>	151~200 <sup>φ</sup>	201~300 <sup>φ</sup>
φ 20	30	16	68	81	93	106	131	12.5	25	37.5	50	75
φ 25	30	16	72	85	97	110	135	12.5	25	37.5	50	75
φ 32	30	16	72	85	97	110	135	12.5	25	37.5	50	75
φ 40	40	18	77	90	102	115	140	12.5	25	37.5	50	75

Boss-Cut Type

Bore Size	LT
φ 20	103
φ 25	107
φ 32	109
φ 40	138

Rod end female thread type

Bore Size	K <sub>1</sub>	H <sub>1</sub>	MM <sub>1</sub>	LT <sub>1</sub>
20	5	20	M4x0.7 dp:8	95
25	5.5	20	M5x0.8 dp:8	95
32	5.5	20	M6x1.0 dp:12	97
40	7	21	M8x1.25 dp:13	125

- ACP
- APM
- AS
- AX**
- AM2
- AM
- AL
- ALX
- AQ
- ADQ
- AQ2
- ADQ2
- AJ
- AJM
- ABK
- ACK1
- NSK
- AG
- NGQ
- AGX
- GX
- NP
- ADR
- AMR
- NDM
- ARD
- NST
- AST
- ASTH
- NLCD
- NLCS

# Series AXK

## Axial Foot Type(L)

AXKL Bore Size Stroke

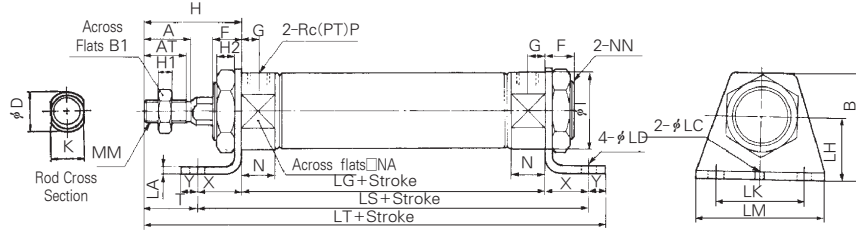

(mm)

Bore Size	A	AT	B	B <sub>1</sub>	B <sub>2</sub>	D	F	G	H	H <sub>1</sub>	H <sub>2</sub>	I	K	LC	LD	LH	LS	LA	LK	LM	MM	N	NA	NN	P	LG	X	Y	T	LT
φ20	18	15.5	40	13	26	10 <sup>-0.01/-0.05</sup>	13	8	41	5	8	27	8 <sup>-0.01/-0.05</sup>	4	6.8	25	102	3.2	40	55	M8×1.25	15	24	M20×1.5	1/8	62	20	8	21	131
φ25	22	19.5	47	17	32	10 <sup>-0.01/-0.05</sup>	13	8	45	6	8	33	8 <sup>-0.01/-0.05</sup>	4	6.8	28	102	3.2	40	55	M8×1.25	15	30	M26×1.5	1/8	62	20	8	25	135
φ32	22	19.5	47	17	32	12 <sup>-0.01/-0.05</sup>	13	8	45	6	8	37.5	10 <sup>-0.01/-0.05</sup>	4	6.8	28	104	3.2	40	55	M10×1.25	15	34.5	M26×1.5	1/8	64	20	8	25	137
φ40	24	21	54	22	41	16 <sup>-0.01/-0.05</sup>	16	11	50	8	10	46.5	14 <sup>-0.01/-0.05</sup>	4	7	30	134	3.2	55	75	M14×1.5	21.5	42.5	M32×2	1/4	88	23	10	27	171

## Rod Side Flange Type(F)

AXKF Bore Size Stroke

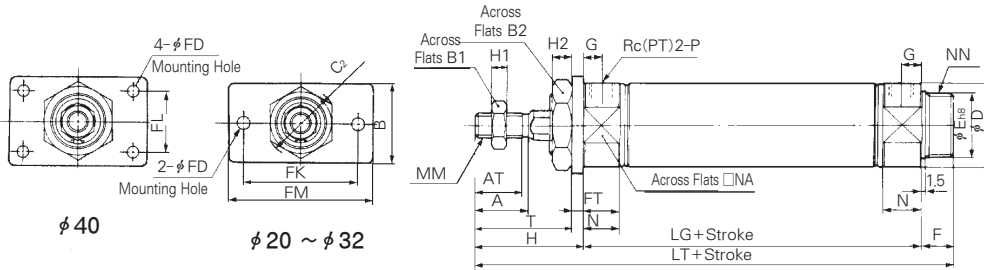

(mm)

Bore Size	A	AT	B	B <sub>1</sub>	B <sub>2</sub>	C <sub>2</sub>	D	E	F	FD	FT	FK	FL	FM	G	H	H <sub>1</sub>	H <sub>2</sub>	I	K	MM
φ20	18	15.5	34	13	26	30	10 <sup>-0.01/-0.05</sup>	20 <sup>0/-0.033</sup>	13	7	4	60	-	75	8	41	5	8	27	8 <sup>-0.01/-0.05</sup>	M8×1.25
φ25	22	19.5	40	17	32	37	10 <sup>-0.01/-0.05</sup>	26 <sup>0/-0.033</sup>	13	7	4	60	-	75	8	45	6	8	33	8 <sup>-0.01/-0.05</sup>	M8×1.25
φ32	22	19.5	40	17	32	37	12 <sup>-0.01/-0.05</sup>	26 <sup>0/-0.033</sup>	13	7	4	60	-	75	8	45	6	8	37.5	10 <sup>-0.01/-0.05</sup>	M10×1.25
φ40	24	21	52	22	41	47.3	16 <sup>-0.01/-0.05</sup>	32 <sup>0/-0.039</sup>	16	7	5	66	36	82	11	50	8	10	46.5	14 <sup>-0.01/-0.05</sup>	M14×1.5

(mm)

Bore Size	N	NA	NN	P	LG	T	LT
φ20	15	24	M20×1.5	1/8	62	37	116
φ25	15	30	M26×1.5	1/8	62	41	120
φ32	15	34.5	M26×1.5	1/8	64	41	122
φ40	21.5	42.5	M32×2	1/4	88	45	154

### Boss-Cut Type

Bore Size	LT
φ20	103
φ25	107
φ32	109
φ40	138

Boss-cut type

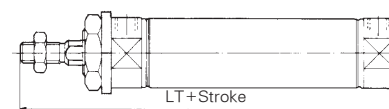

# Series AXK

## Head Side Flange Type(G)

AXKG Bore Size Stroke

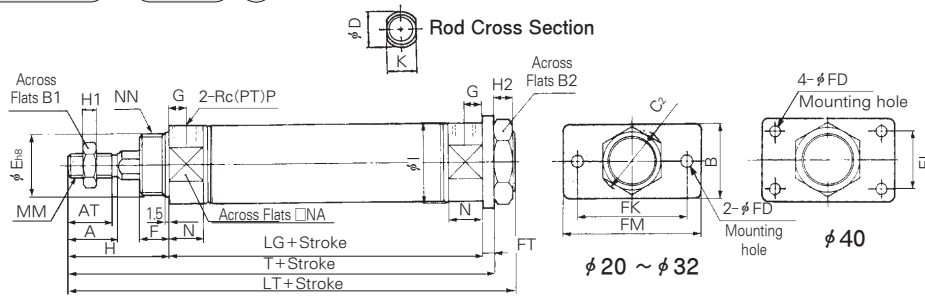

(mm)

Bore Size	A	AT	B	B <sub>1</sub>	B <sub>2</sub>	C <sub>2</sub>	D	E	F	FD	FT	FK	FL	FM	G	H	H <sub>1</sub>	H <sub>2</sub>	I	K	MM
φ 20	18	15.5	34	13	26	30	10 <sup>-0.01/-0.05</sup>	20 <sup>0/-0.033</sup>	13	7	4	60	—	75	8	41	5	8	27	8 <sup>-0.01/-0.05</sup>	M8×1.25
φ 25	22	19.5	40	17	32	37	10 <sup>-0.01/-0.05</sup>	26 <sup>0/-0.033</sup>	13	7	4	60	—	75	8	45	6	8	33	8 <sup>-0.01/-0.05</sup>	M8×1.25
φ 32	22	19.5	40	17	32	37	12 <sup>-0.01/-0.05</sup>	26 <sup>0/-0.033</sup>	13	7	4	60	—	75	8	45	6	8	37.5	10 <sup>-0.01/-0.05</sup>	M10×1.25
φ 40	24	21	52	22	41	47.3	16 <sup>-0.01/-0.05</sup>	32 <sup>0/-0.039</sup>	16	7	5	66	36	82	10	50	8	10	46.5	14 <sup>-0.01/-0.05</sup>	M14×1.5

Bore Size	N	NA	NN	P	LG	T	LT
φ 20	15	24	M20×1.5	1/8	62	107	116
φ 25	15	30	M26×1.5	1/8	62	111	120
φ 32	15	34.5	M26×1.5	1/8	64	113	122
φ 40	21.5	42.5	M32×2	1/4	88	143	154

## Single Clevis Type (C)

AXKC Bore Size Stroke

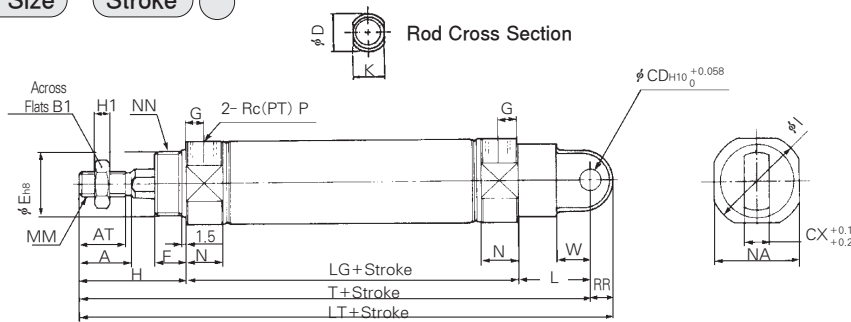

(mm)

Bore Size	A	AT	B <sub>1</sub>	CD	CX	D	E	F	G	H	H <sub>1</sub>	I	K	L	MM	N	NA	NN	P	RR
φ 20	18	15.5	13	9	10	10 <sup>-0.01/-0.05</sup>	20 <sup>0/-0.033</sup>	13	8	41	5	27	8 <sup>-0.01/-0.05</sup>	30	M8×1.25	15	24	M20×1.5	1/8	9
φ 25	22	19.5	17	9	10	10 <sup>-0.01/-0.05</sup>	26 <sup>0/-0.033</sup>	13	8	45	6	33	8 <sup>-0.01/-0.05</sup>	30	M8×1.25	15	30	M26×1.5	1/8	9
φ 32	22	19.5	17	9	10	12 <sup>-0.01/-0.05</sup>	26 <sup>0/-0.033</sup>	13	8	45	6	37.5	10 <sup>-0.01/-0.05</sup>	30	M10×1.25	15	34.5	M26×1.5	1/8	9
φ 40	24	21	22	10	15	16 <sup>-0.01/-0.05</sup>	32 <sup>0/-0.039</sup>	16	11	50	8	46.5	14 <sup>-0.01/-0.05</sup>	39	M14×1.5	21.5	42.5	M32×2	1/4	11

Bore Size	LG	W	T	LT
φ 20	62	14	133	142
φ 25	62	14	137	146
φ 32	64	14	139	148
φ 40	88	18	177	188

- ACP
- APM
- AS
- AX**
- AM2
- AM
- AL
- ALX
- AQ
- ADQ
- AQ2
- ADQ2
- AJ
- AJM
- ABK
- ACK1
- NSK
- AG
- NGQ
- AGX
- GX
- NP
- ADR
- AMR
- NDM
- ARD
- NST
- AST
- ASTH
- NLCD
- NLCS

# Series AXK

## Double Clevis Type(D)

AXKD  Bore Size  Stroke

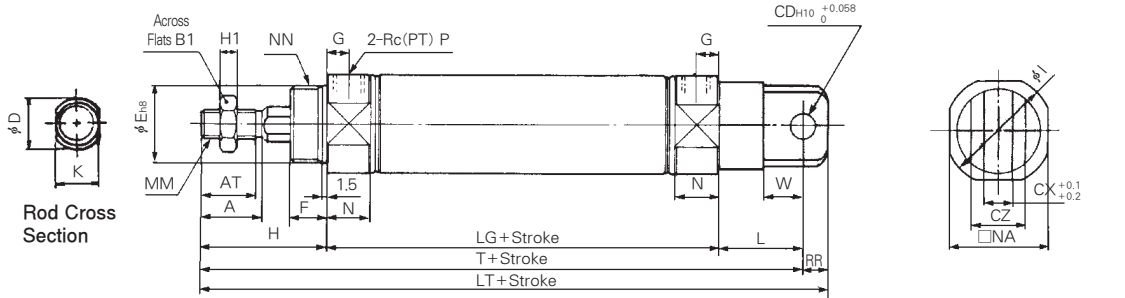

(mm)

Bore Size	A	AT	B <sub>1</sub>	CD	CX	CZ	D	E	F	G	H	H <sub>1</sub>	I	K	L	MM	N	NA	NN	P	RR	LG	W	T	LT
φ20	18	15.5	13	9	10	19	$10_{-0.05}^{0.01}$	$20_{-0.033}^0$	13	8	41	5	27	$8_{-0.05}^{-0.01}$	30	M8×1.25	15	24	M20×1.5	1/8	9	62	14	133	142
φ25	22	19.5	17	9	10	19	$10_{-0.05}^{-0.01}$	$26_{-0.033}^0$	13	8	45	6	33	$8_{-0.05}^{-0.01}$	30	M8×1.25	15	30	M26×1.5	1/8	9	62	14	137	146
φ32	22	19.5	17	9	10	19	$12_{-0.05}^{-0.01}$	$26_{-0.033}^0$	13	8	45	6	37.5	$10_{-0.05}^{-0.01}$	30	M10×1.25	15	34.5	M26×1.5	1/8	9	64	14	139	148
φ40	24	21	22	10	15	30	$16_{-0.05}^{-0.01}$	$32_{-0.039}^0$	16	11	50	8	46.5	$14_{-0.05}^{-0.01}$	39	M14×1.5	21.5	42.5	M32×2	1/4	11	88	18	177	188

## Rod Side Trunnion Type(U)

AXKU  Bore Size  Stroke

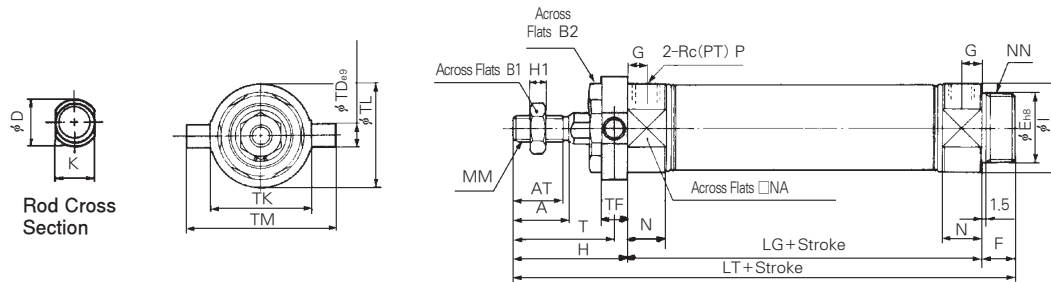

(mm)

Bore Size	A	AT	B <sub>1</sub>	B <sub>2</sub>	D	E	F	G	H	H <sub>1</sub>	I	K	MM	N	NA	NN	P	LG	TD	TF
φ20	18	15.5	13	26	$10_{-0.05}^{-0.01}$	$20_{-0.033}^0$	13	8	41	5	27	$8_{-0.05}^{-0.01}$	M8×1.25	15	24	M20×1.5	1/8	62	8	10
φ25	22	19.5	17	32	$10_{-0.05}^{-0.01}$	$26_{-0.033}^0$	13	8	45	6	33	$8_{-0.05}^{-0.01}$	M8×1.25	15	30	M26×1.5	1/8	62	9	10
φ32	22	19.5	17	32	$12_{-0.05}^{-0.01}$	$26_{-0.033}^0$	13	8	45	6	37.5	$10_{-0.05}^{-0.01}$	M10×1.25	15	34.5	M26×1.5	1/8	64	9	10
φ40	24	21	22	41	$16_{-0.05}^{-0.01}$	$32_{-0.039}^0$	16	11	50	8	46.5	$14_{-0.05}^{-0.01}$	M14×1.5	21.5	42.5	M32×2	1/4	88	10	11

### Boss-Cut Type

Bore Size	TK	TL	TM	T	LT
φ20	32	32	52	36	116
φ25	40	40	60	40	120
φ32	40	40	60	40	122
φ40	53	53	77	44.5	154

Bore Size	LT
φ20	103
φ25	107
φ32	109
φ40	138

### Boss-Cut Type

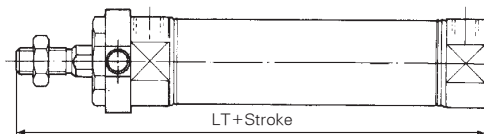



## Head Side Trunnion Type(T)

AXKT Bore size Stroke

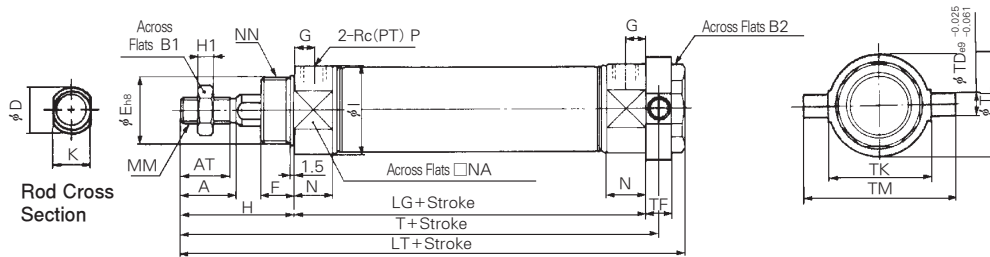

Bore Size	A	AT	B <sub>1</sub>	B <sub>2</sub>	D	E	F	G	H	H <sub>i</sub>	I	K	MM	N	NA	NN	P	LG	TD	TF
φ 20	18	15.5	13	26	10 <sup>-0.01/-0.05</sup>	20 <sup>0/-0.033</sup>	13	8	41	5	27	8 <sup>-0.01/-0.05</sup>	M8×1.25	15	24	M20×1.5	1/8	62	8	10
φ 25	22	19.5	17	32	10 <sup>-0.01/-0.05</sup>	26 <sup>0/-0.033</sup>	13	8	45	6	33	8 <sup>-0.01/-0.05</sup>	M8×1.25	15	30	M26×1.5	1/8	62	9	10
φ 32	22	19.5	17	32	12 <sup>-0.01/-0.05</sup>	26 <sup>0/-0.033</sup>	13	8	45	6	37.5	10 <sup>-0.01/-0.05</sup>	M10×1.25	15	34.5	M26×1.5	1/8	64	9	10
φ 40	24	21	22	41	16 <sup>-0.01/-0.05</sup>	32 <sup>0/-0.039</sup>	16	11	50	8	46.5	14 <sup>-0.01/-0.05</sup>	M14×1.5	21.5	42.5	M32×2	1/4	88	10	11

Bore Size	TK	TL	TM	T	LT
φ 20	32	32	52	108	118
φ 25	40	40	60	112	122
φ 32	40	40	60	114	124
φ 40	53	53	77	143.5	154

## Integrated Clevis Type(E)

AXKE Bore Size Stroke

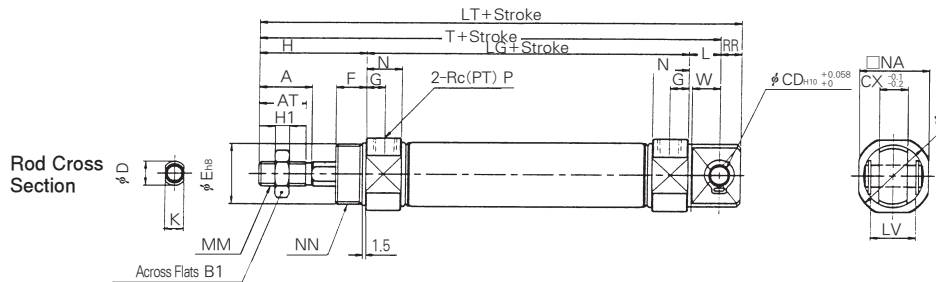

Bore Size	A	AT	B <sub>1</sub>	CD	CX	D	E	F	G	H	H <sub>i</sub>	I	K	L	MM	N	NA	NN	P	RR
φ 20	18	15.5	13	8	12	10 <sup>-0.01/-0.05</sup>	20 <sup>0/-0.033</sup>	13	8	41	5	27	8 <sup>-0.01/-0.05</sup>	12	M8×1.25	15	24	M20×1.5	1/8	9
φ 25	22	19.5	17	8	12	10 <sup>-0.01/-0.05</sup>	26 <sup>0/-0.033</sup>	13	8	45	6	33	8 <sup>-0.01/-0.05</sup>	12	M8×1.25	15	30	M26×1.5	1/8	9
φ 32	22	19.5	17	10	20	12 <sup>-0.01/-0.05</sup>	26 <sup>0/-0.033</sup>	13	8	45	6	37.5	10 <sup>-0.01/-0.05</sup>	15	M10×1.25	15	34.5	M26×1.5	1/8	12
φ 40	24	21	22	10	20	16 <sup>-0.01/-0.05</sup>	32 <sup>0/-0.039</sup>	16	11	50	8	46.5	14 <sup>-0.01/-0.05</sup>	15	M14×1.5	21.5	42.5	M32×2	1/4	12

Bore Size	LG	W	T	LT	LV
φ 20	62	11.5	115	124	18.4
φ 25	62	11.5	119	128	18.4
φ 32	64	14.5	124	136	28
φ 40	88	14.5	153	165	28

- ACP
- APM
- AS
- AX
- AM2
- AM
- AL
- ALX
- AQ
- ADQ
- AQ2
- ADQ2
- AJ
- AJM
- ABK
- ACK1
- NSK
- AG
- NGQ
- AGX
- GX
- NP
- ADR
- AMR
- NDM
- ARD
- NST
- AST
- ASTH
- NLCD
- NLCS

# Series AXKS(T)

## Non-Rotating Piston Rod Type/Single Acting:Spring Return, Spring Extended

Bore Size(mm) : Ø20, Ø25, Ø32, Ø40



- NUMEROUS MOUNTING OPTIONS
- MAGNET STANDARD FOR AUTO SWITCH
- BUMPERS STANDARD
- DESIGNED FOR NON-LUBRICATED SERVICE
- COMPACT LIGHT DESIGN
- REPLACEABLE ROD GLAND
- CUSTOM DESIGNED PISTON ROD FOR NON-ROTATION AND LONG ROD SEAL LIFE

Symbol

Single Acting Spring Return

Single Acting Spring Extended

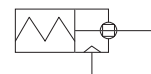
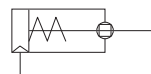

### How to Order

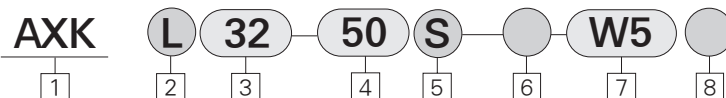

#### 1 Non-Rotating Piston Rod Type

※ Built-in Magnet Standard

#### 2 Mounting

B : Basic Type  
L : Axial Foot Type  
F : Rod Side Flange Type  
G : Head Side Flange Type  
C : Single Clevis Type  
D : Double Clevis Type  
T : Head Side Trunnion Type  
U : Rod Side Trunnion Type  
E : Integrated Clevis Type  
BZ : Boss-Cut Basic Type  
FZ : Boss-Cut Flange Type  
UZ : Boss-Cut Trunnion Type

#### 3 Bore Size(mm)

20 : φ20  
25 : φ25  
32 : φ32  
40 : φ40

#### 4 Stroke/mm

φ20 : 25, 50, 75, 100, 125, 150  
φ25 : 25, 50, 75, 100, 125, 150

32 : 25, 50, 75, 100, 125, 150, 200  
40 : 25, 50, 75, 100, 125, 150, 200, 250

#### 5 Action

S : Single Acting Spring Return  
T : Single Acting Spring Extend

#### 6 Rod end thread type

Blank : Rod end male thread  
F : Rod end female thread

#### 7 Auto Switch

(Band mounted type)  
(Grommet)  
Blank : None  
W5 : Reed Switch, 0.5m Lead Wire  
W5L : Reed Switch, 3m Lead Wire

#### 8 Number of Auto Switches

Blank : 2 pcs  
S : 1 pc  
N : N pcs

#### PART No. of Mounting Bracket

Bore Size(mm)	20	25, 32	40
※ Axial foot	TCM-L020B	TCM-L032B	TCM-L040B
Flange	TCM-F020B	TCM-F032B	TCM-F040B
Single Clevis	TCM-C020B	TCM-C032B	TCM-C040B
Double Clevis	TCM-D020B	TCM-D032B	TCM-D040B
Trunnion (With nut)	TCM-T020B	TCM-T032B	TCM-T040B

2pcs. Required per one cylinder.

#### PART No. of Auto switch Mounting Band

Auto Switch Model	Bore Size(mm)			
	20	25	32	40
W5	TBM2-020	TBM2-025	TBM2-032	TBM2-040

## Series AXKS(T)

Model					
Bore Size(mm)		$\phi$ 20	$\phi$ 25	$\phi$ 32	$\phi$ 40
Type		Air Cylinder			
Cushion		Rubber Cushion (Standard)			
Piping Method	Screwed Type	Rc(PT)1/8	Rc(PT)1/8	Rc(PT)1/8	Rc(PT)1/4
Auto Switch (Band Mounted Type)		Reed Auto Switch /W5			

Specifications		
Action	Spring Return	Spring Extended
Fluid	Air	
Proof Pressure	1.5 MPa (213psi)	
Max. Operating Pressure	1.0 MPa (140psi)	
Min. Operating Pressure	0.18Mpa (25psi)	0.23Mpa (32psi)
Ambient and Fluid Temperature	-10~+70°C (14~158°F)	
Lubrication	None (Non-Lube)	
Thread Tolerance	KS 2 Class	
Stroke Tolerance	+1.4 0 mm	
Mounting	Basic Type, Axial Foot Type, Rod Side Flange Type, Head Side Flange Type, Single Clevis Type, Double Clevis Type, Rod Side Trunnion Type, Head Side Trunnion Type, Integrated Clevis Type, Boss-Cut Type.	
Non-Rotating Accuracy	$\phi$ 20, $\phi$ 25	$\pm 0.8^\circ$
	$\phi$ 32, $\phi$ 40	$\pm 0.5^\circ$

Piston Speed				
Bore Size (mm)	$\phi$ 20	$\phi$ 25	$\phi$ 32	$\phi$ 40
Piston Speed (mm/sec)	50~500			
Allowable Kinetic Energy (kgf-cm)	2.7	4	6.5	12

Auto Switch Specifications		
Mounting	Lead Wire Entry	Reed Switch
Band Mounting Type	Grommet	W5

- ACP
- APM
- AS
- AX**
- AM2
- AM
- AL
- ALX
- AQ
- ADQ
- AQ2
- ADQ2
- AJ
- AJM
- ABK
- ACK1
- NSK
- AG
- NGQ
- AGX
- GX
- NP
- ADR
- AMR
- NDM
- ARD
- NST
- AST
- ASTH
- NLCD
- NLCS

## Series AXKS(T)

### Boss-Cut Type

Boss for the head cover bracket is eliminated and the total length of the cylinder is shortened.

### Compared to the Total Length of Cylinder

(Compared to the basic type) (mm)			
φ 20	φ 25	φ 32	φ 40
▼13	▼13	▼13	▼16

### Mounting

- Boss-Cut Basic Type (BZ)
- Boss-Cut Flange Type (FZ)
- Boss-Cut Trunnion Type (UZ)

\* Spring return/( ) : spring extended

### Mounting and Accessories

Accessories	Standard			Option	
	Mounting Nut	Rod End Nut	Clevis Pin	Single Knuckle Joint	Double Knuckle Joint
Basic Type	○ (1pc.)	○	-	○	○
Axial Foot Type	○ (2)	○	-	○	○
Rod Side Flange Type	○ (1)	○	-	○	○
Head Side Flange Type	○ (1)	○	-	○	○
Integrated Clevis Type	-	○	-	○	○
Single Clevis Type	-	○	-	○	○
Double Clevis Type	-	○	○	○	○
Head Side Trunnion Type	○ (1)	○	-	○	○
Rod Side Trunnion Type	○ (1)	○	-	○	○
Boss-Cut Basic Type	○ (1)	○	-	○	○
Boss-Cut Flange Type	○ (1)	○	-	○	○
Boss-Cut Trunnion Type	○ (1)	○	-	○	○
Note					With pin

### Single Acting Spring Return (Spring Extended)

kgf

Bore Size (mm)		φ 20	φ 25	φ 32	φ 40
Basic Weight	25 Stroke	0.21(0.20)	0.31(0.30)	0.43(0.41)	0.78(0.75)
	50 Stroke	0.23(0.21)	0.34(0.33)	0.48(0.45)	0.86(0.83)
	75 Stroke	0.29(0.25)	0.43(0.41)	0.61(0.56)	1.08(0.99)
	100 Stroke	0.31(0.27)	0.47(0.44)	0.66(0.60)	1.14(1.06)
	125 Stroke	0.38(0.33)	0.56(0.52)	0.81(0.73)	1.34(1.23)
	150 Stroke	0.39(0.34)	0.59(0.55)	0.85(0.76)	1.39(1.31)
	175 Stroke	-(-)	-(-)	1.04(0.93)	1.71(1.54)
	200 Stroke	-(-)	-(-)	-(-)	2.00(1.78)
Mounting Bracket Weight	Foot type	0.15(0.15)	0.16(0.16)	0.16(0.16)	0.27(0.28)
	Flange type	0.06(0.06)	0.09(0.09)	0.09(0.09)	0.12(0.12)
	Single clevis type	0.04(0.04)	0.04(0.04)	0.04(0.04)	0.09(0.09)
	Double Knuckle Joint (with PIN) type	0.05(0.05)	0.06(0.06)	0.06(0.06)	0.13(0.13)
	Double clevis type	0.04(0.05)	0.07(0.07)	0.07(0.07)	0.10(0.11)
	Trunnion type	-0.02(-0.02)	-0.02(-0.02)	-0.01(-0.01)	-0.04(-0.04)
	Integrated clevis type	-0.01(-0.01)	-0.02(-0.02)	-0.02(-0.02)	-0.03(-0.03)
	Boss-cut basic type	0.05(0.05)	0.07(0.07)	0.07(0.07)	0.09(0.09)
Accessories	Boss-cut flange type	0.03(0.03)	0.05(0.05)	0.05(0.05)	0.07(0.07)
	Boss-cut trunnion type	0.06(0.06)	0.06(0.06)	0.06(0.06)	0.23(0.23)
	Single knuckle joint type	0.07(0.07)	0.07(0.07)	0.07(0.07)	0.20(0.21)

Calculation

Example: AXKL32-100S (Bore size φ 32, Foot type, 100st)

Basic weight:  $0.66 + (\text{Mounting bracket weight}) 0.16 = 0.82 \text{ kgf}$

# Series AXKS(T)

## ⚠ Precautions

Be sure to read before handling. Refer to P A-2 for safety instructions and common precautions.

## Handling

- Avoid using the air cylinder in such a way that rotational torque would be applied to the piston rod. If rotational torque is applied, the non-rotation guide will become deformed, thus affecting the non-rotating accuracy. Refer to table below for the approximate values of the allowable range of rotational torque.

Allowable rotational torque	φ 20	φ 25	φ 32	φ 40
kg · f · cm	2.0	2.5	2.5	4.5

- The cylinder has been lubricated for life at the factory and can be used without any further lubrication.
- However, in the event that it will be lubricated, use class 1 turbine oil (with no additives) ISO VG32.

## Mounting/Piping

- To screw a bracket or a nut onto the threaded portion at the tip of the piston rod, make sure to retract the piston rod entirely, and place a wrench over the flat portion of the rod that protrudes. To tighten, take precautions to prevent the tightening torque from being applied to the non-rotating guide.
- Before piping is connected, it should be thoroughly blown out with air (flushing) or washed to remove cutting chips, cutting oil and other debris from inside the pipe.

## Construction / Parts List

### Spring Return Type

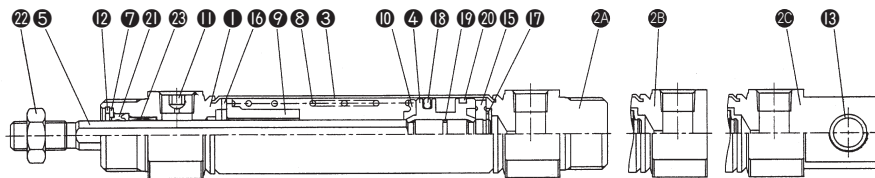

### Spring Extended Type

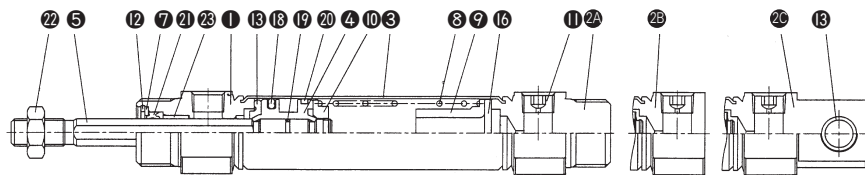

## Parts List

No.	Description	Material	Remarks
1	Rod Cover	Aluminum Alloy	White Alumite
2A	Head Cover-A	Aluminum Alloy	White Alumite
2B	Head Cover-B	Aluminum Alloy	White Alumite
2C	Head Cover-C	Aluminum Alloy	White Alumite
3	Cylinder Tube	Stainless Steel	
4	Piston	Aluminum Alloy	Chromate
5	Piston Rod	Stainless Steel	
6	Guide Bush	Lead Bronze Casting	
7	Retaining Ring	Rolled Steel	Nickel Plated
8	Spring return	Steel Wire	Zinc Chromate
9	Spring Guide	Aluminum Alloy	Chromate
10	Spring maintenance	Aluminum Alloy	Chromate
11	Fixed orifice mounted plug	Alloy Steel	Black Zinc Chromate
12	Stopper ring	Carbon Tool Steel	Nickel Plated
13	Bush for clevis	Lead Bronze Casting	

No.	Description	Material	Remarks
15	DAMPER A	Urethane	
16	DAMPER B	Urethane	
17	Stopper ring	Carbon Tool steel	
18	Piston Paeking	NBR	
19	Piston Gasket	NBR	
20	Wear ring	Resin	
22	Rod End Nut	Carbon steel	Nickel Plated
23	Bush		

## SPARE Parts

No.	Description	Material	Bore Size(mm)			
			20	25	32	40
21	Rod Packing	NBR	SORA-10	SORA-10	SORA-12	SORA-16

ACP

APM

AS

AX

AM2

AM

AL  
ALX

AQ  
ADQ

AQ2  
ADQ2

AJ  
AJM

ABK

ACK1

NSK

AG

NGQ

AGX  
GX

NP

ADR

AMR

NDM

ARD

NST

AST

ASTH

NLCD

NLCS

# Series AXKS(T)

## Basic Type (B)

AXKB Bore Size Stroke S

### Basic Type

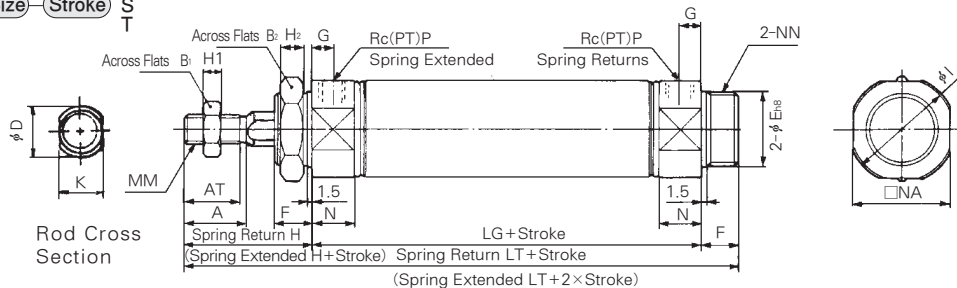

### Boss-Cut Type

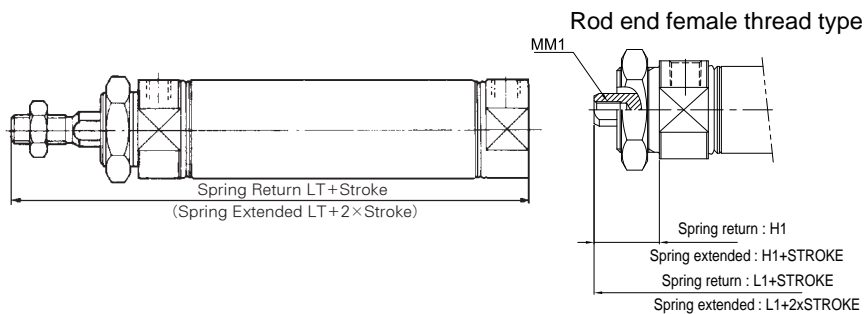

※ This drawing is spring extended

Bore Size	A	AT	B <sub>1</sub>	B <sub>2</sub>	D	E	F	G	H	H <sub>1</sub>	H <sub>2</sub>	I	K	MM	N	NA	NN	P
20	18	15.5	13	26	10 <sup>-0.01/-0.05</sup>	20 <sup>0/-0.033</sup>	13	8	41	5	8	27	8 <sup>-0.01/-0.05</sup>	M8x1.25	15	24	M20x1.5	1/8
25	22	19.5	17	32	10 <sup>-0.01/-0.05</sup>	26 <sup>0/-0.033</sup>	13	8	45	6	8	33	8 <sup>-0.01/-0.05</sup>	M8x1.25	15	30	M26x1.5	1/8
32	22	19.5	17	32	12 <sup>-0.01/-0.05</sup>	26 <sup>0/-0.033</sup>	13	8	45	6	8	37.5	10 <sup>-0.01/-0.05</sup>	M10x1.25	15	34.5	M26x1.5	1/8
40	24	21	22	41	16 <sup>-0.01/-0.05</sup>	32 <sup>0/-0.039</sup>	16	11	50	8	10	46.5	14 <sup>-0.01/-0.05</sup>	M14x1.5	21.5	42.5	M32x2	1/4

### Stroke Dimension Adder (mm)

Stroke Symbol	1~50		51~100		101~150		151~200		201~250	
	LG	LT	LG	LT	LG	LT	LG	LT	LG	LT
φ20	87	141	112	166	137	191	-	-	-	-
φ25	87	145	112	170	137	195	-	-	-	-
φ32	89	147	114	172	139	197	164	222	-	-
φ40	113	179	138	204	163	229	188	254	213	279

### Boss-Cut Type (mm)

Stroke Symbol	1~50	51~100	101~150	151~200	201~250
	LT	LT	LT	LT	LT
φ20	128	153	178	-	-
φ25	132	157	182	-	-
φ32	134	159	184	209	-
φ40	163	188	213	238	263

### Rod end female thread type

Bore Size	H <sub>1</sub>	MM <sub>1</sub>	1~50	51~100	101~150	151~200	201~250
			LT <sub>1</sub>	LT <sub>1</sub>	LT <sub>1</sub>	LT <sub>1</sub>	LT <sub>1</sub>
20	20	M4x0.7 dp:8	120	145	170	-	-
25	20	M5x0.8 dp:8	120	145	170	-	-
32	20	M6x1.0 dp:12	122	147	172	197	-
40	21	M8x1.25 dp:13	150	175	200	225	250

# Series AXKS(T)

## Foot Type(L)

AXKL **Bore Size**—**Stroke**  $\frac{S}{T}$

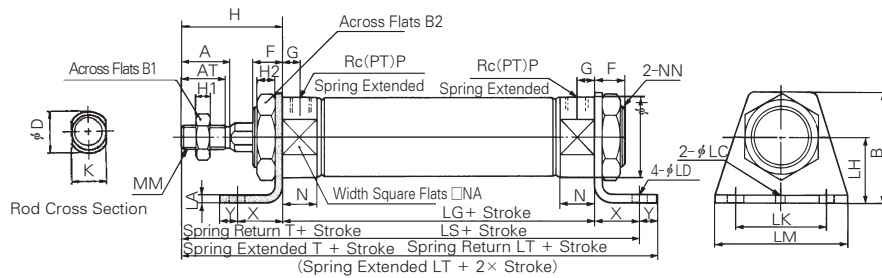

※ This drawing is spring extended

(mm)

Bore Size	A	AT	B	B <sub>1</sub>	B <sub>2</sub>	D	F	G	H	H <sub>1</sub>	H <sub>2</sub>	I	K	LC	LD	LH	LA	LK	LM	MM	N	NA	NN	P	X	Y	T
φ20	18	15.5	40	13	26	10 <sup>-0.01/-0.05</sup>	13	8	41	5	8	27	8 <sup>-0.01/-0.05</sup>	4	6.8	25	3.2	40	55	M8×1.25	15	24	M20×1.5	1/8	20	8	21
φ25	22	19.5	47	17	32	10 <sup>-0.01/-0.05</sup>	13	8	45	6	8	33	8 <sup>-0.01/-0.05</sup>	4	6.8	28	3.2	40	55	M8×1.25	15	30	M26×1.5	1/8	20	8	25
φ32	22	19.5	47	17	32	12 <sup>-0.01/-0.05</sup>	13	8	45	6	8	37.5	10 <sup>-0.01/-0.05</sup>	4	6.8	28	3.2	40	55	M10×1.25	15	34.5	M26×1.5	1/8	20	8	25
φ40	24	21	54	22	41	16 <sup>-0.01/-0.05</sup>	16	11	50	8	10	46.5	14 <sup>-0.01/-0.05</sup>	4	7	30	3.2	55	75	M14×1.5	21.5	42.5	M32×2	1/4	23	10	27

### Stroke Dimension Adder

Stroke Symbol	1~50			51~100			101~150			151~200			201~250		
	LG	LS	LT	LG	LS	LT	LG	LS	LT	LG	LS	LT	LG	LS	LT
φ20	87	127	156	112	152	181	137	177	206	—	—	—	—	—	—
φ25	87	127	160	112	152	185	137	177	210	—	—	—	—	—	—
φ32	89	129	162	114	154	187	139	179	212	164	204	237	—	—	—
φ40	113	159	196	138	184	221	163	209	246	188	234	271	213	259	296

## Head Side Flange Type(G)

AXKG **Bore Size**—**Stroke**  $\frac{S}{T}$

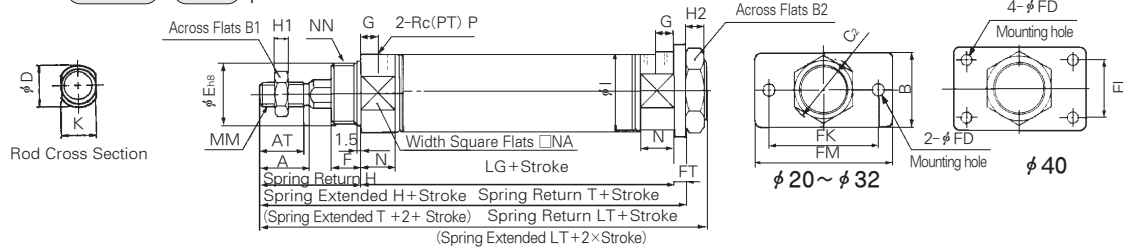

※ This drawing is spring extended

(mm)

Bore Size	A	AT	B	B <sub>1</sub>	B <sub>2</sub>	C <sub>2</sub>	D	E	F	FD	FT	FK	FL	FM	G	H	H <sub>1</sub>	H <sub>2</sub>	I	K	MM	N	NA	NN	P	T
φ20	18	15.5	34	13	26	30	10 <sup>-0.01/-0.05</sup>	20 <sup>-0/-0.033</sup>	13	7	4	60	—	75	8	41	5	8	27	8 <sup>-0.01/-0.05</sup>	M8×1.25	15	24	M20×1.5	1/8	37
φ25	22	19.5	40	17	32	37	10 <sup>-0.01/-0.05</sup>	26 <sup>-0/-0.033</sup>	13	7	4	60	—	75	8	45	6	8	33	8 <sup>-0.01/-0.05</sup>	M8×1.25	15	30	M26×1.5	1/8	41
φ32	22	19.5	40	17	32	37	12 <sup>-0.01/-0.05</sup>	26 <sup>-0/-0.033</sup>	13	7	4	60	—	75	8	45	6	8	37.5	10 <sup>-0.01/-0.05</sup>	M10×1.25	15	34.5	M26×1.5	1/8	41
φ40	24	21	52	22	41	47.3	16 <sup>-0.01/-0.05</sup>	32 <sup>-0/-0.039</sup>	16	7	5	66	36	82	11	50	8	11	46.5	14 <sup>-0.01/-0.05</sup>	M14×1.5	21.5	42.5	M30×2	1/4	45

### Stroke Dimension Adder

(Unit : mm)

Stroke Symbol	1~50			51~100			101~150			151~200			201~250		
	LG	T	LT	LG	T	LT	LG	T	LT	LG	T	LT	LG	T	LT
φ20	87	132	141	112	157	166	137	182	191	—	—	—	—	—	—
φ25	87	136	145	112	161	170	137	186	195	—	—	—	—	—	—
φ32	89	138	147	114	163	172	139	188	197	164	213	222	—	—	—
φ40	113	168	179	138	193	204	163	218	229	188	243	254	213	268	279

ACP

APM

AS

AX

AM2

AM

AL  
ALX

AQ  
ADQ

AQ2  
ADQ2

AJ  
AJM

ABK

ACK1

NSK

AG

NGQ

AGX  
GX

NP

ADR

AMR

NDM

ARD

NST

AST

ASTH

NLCD

NLCS

# Series AXKS(T)

## Rod Side Flange Type(F)

AXKF Bore Size - Stroke †

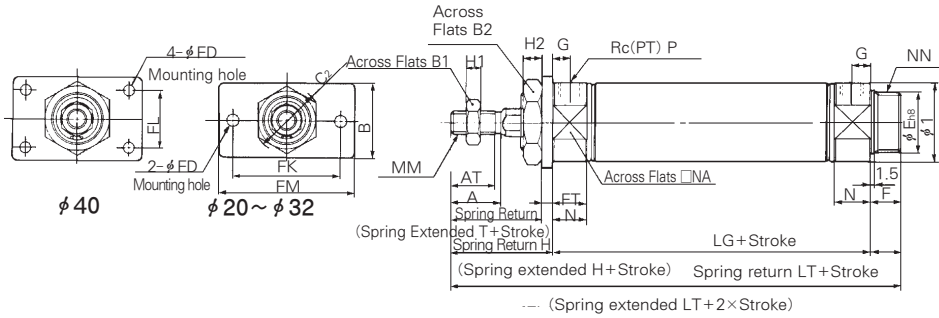

## Boss-Cut type

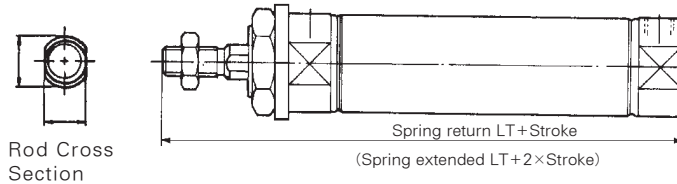

※ This drawing is spring extended

(mm)

Bore Size	A	AT	B	B <sub>1</sub>	B <sub>2</sub>	C <sub>2</sub>	D	E	F	FD	FT	FK	FL	FM	G	H	H <sub>1</sub>	H <sub>2</sub>	I	K	MM	N	NA	NN	P	T
φ20	18	15.5	34	13	26	30	10 <sup>-0.01/-0.05</sup>	20 <sup>0/-0.033</sup>	13	7	4	60	-	75	8	41	5	8	27	8 <sup>-0.01/-0.05</sup>	M8×1.25	15	24	M20×1.5	1/8	37
φ25	22	19.5	40	17	32	37	10 <sup>-0.01/-0.05</sup>	26 <sup>0/-0.033</sup>	13	7	4	60	-	75	8	45	6	8	33	8 <sup>-0.01/-0.05</sup>	M8×1.25	15	30	M26×1.5	1/8	41
φ32	22	19.5	40	17	32	37	12 <sup>-0.01/-0.05</sup>	26 <sup>0/-0.033</sup>	13	7	4	60	-	75	8	45	6	8	37.5	10 <sup>-0.01/-0.05</sup>	M10×1.25	15	34.5	M26×1.5	1/8	41
φ40	24	21	52	22	41	47.3	16 <sup>-0.01/-0.05</sup>	32 <sup>0/-0.033</sup>	16	7	5	66	36	82	11	50	8	10	46.5	14 <sup>-0.01/-0.05</sup>	M14×1.5	21.5	42.5	M32×2	1/4	45

### Stroke Dimension Adder (mm)

Stroke Symbol	1~50		51~100		101~150		151~200		201~250	
	LG	LT	LG	LT	LG	LT	LG	LT	LG	LT
φ20	87	141	112	166	137	191	-	-	-	-
φ25	87	145	112	170	137	195	-	-	-	-
φ32	89	147	114	172	139	197	164	222	-	-
φ40	113	179	138	204	163	229	188	254	213	279

### Boss-Cut Type/Distinction of Stroke (mm)

Stroke Symbol	1~50		51~100		101~150		151~200		201~250	
	LT	LT	LT	LT	LT	LT	LT	LT	LT	
φ20	128	153	178	-	-	-	-	-	-	
φ25	132	157	182	-	-	-	-	-	-	
φ32	134	159	184	209	-	-	-	-	-	
φ40	163	188	213	238	263	-	-	-	-	



# Series AXKS(T)

## Single Clevis Type (C)

AXKG Bore Size—Stroke  $\frac{S}{T}$

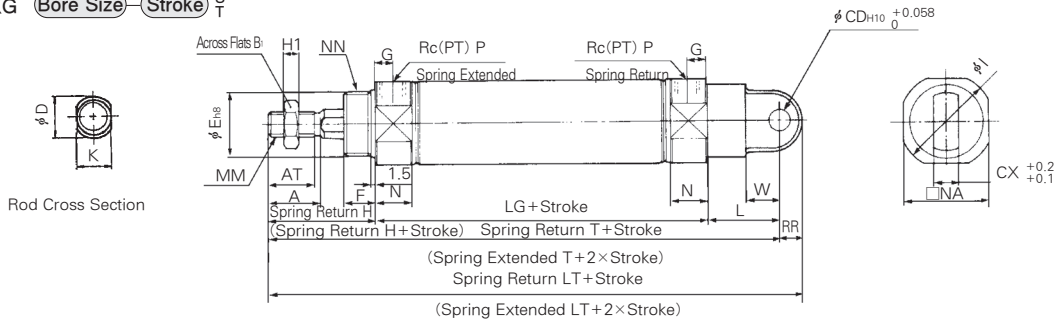

※ This drawing is spring extended

(mm)

Bore Size	A	AT	B <sub>1</sub>	CD	CX	D	E	F	G	H	H <sub>1</sub>	I	K	L	MM	N	NA	NN	P	RR	W
φ20	18	15.5	13	9	10	10 <sup>-0.01/-0.05</sup>	20 <sup>0/-0.033</sup>	13	8	41	5	27	8 <sup>-0.01/-0.05</sup>	30	M8×1.25	15	24	M20×1.5	1/8	9	14
φ25	22	19.5	17	9	10	10 <sup>-0.01/-0.05</sup>	26 <sup>0/-0.033</sup>	13	8	45	6	33	8 <sup>-0.01/-0.05</sup>	30	M8×1.25	15	30	M26×1.5	1/8	9	14
φ32	22	19.5	17	9	10	12 <sup>-0.01/-0.05</sup>	26 <sup>0/-0.033</sup>	13	8	45	6	37.5	10 <sup>-0.01/-0.05</sup>	30	M10×1.25	15	34.5	M26×1.5	1/8	9	14
φ40	24	21	22	10	15	16 <sup>-0.01/-0.05</sup>	32 <sup>0/-0.039</sup>	16	11	50	8	46.5	14 <sup>-0.01/-0.05</sup>	39	M14×1.5	21.5	42.5	M32×2	1/4	11	18

### Stroke Dimension Adder

Stroke Symbol	1~50			51~100			101~150			151~200			201~250			
	Bore Size	LG	T	LT	LG	T	LT	LG	T	LT	LG	T	LT	LG	T	LT
φ20	87	158	167	112	183	192	137	208	217	—	—	—	—	—	—	—
φ25	87	162	171	112	187	196	137	212	221	—	—	—	—	—	—	—
φ32	89	164	173	114	189	198	139	214	223	164	239	248	—	—	—	—
φ40	113	202	213	138	227	238	163	252	263	188	277	288	213	302	313	—

## Double Clevis Type (D)

AXKG Bore Size—Stroke  $\frac{S}{T}$

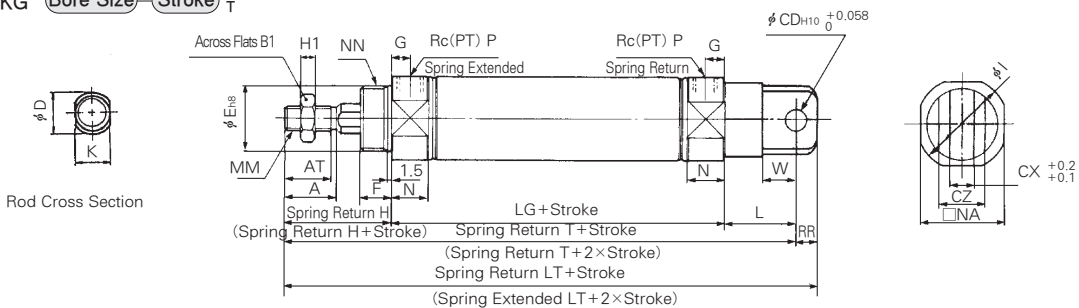

※ This drawing is spring extended

(mm)

Bore Size	A	AT	B <sub>1</sub>	CD	CX	CZ	D	E	F	G	H	H <sub>1</sub>	I	K	L	MM	N	NA	NN	P	RR	W
φ20	18	15.5	13	9	10	19	10 <sup>-0.01/-0.05</sup>	20 <sup>0/-0.033</sup>	13	8	41	5	27	8 <sup>-0.01/-0.05</sup>	30	M8×1.25	15	24	M20×1.5	1/8	9	14
φ25	22	19.5	17	9	10	19	10 <sup>-0.01/-0.05</sup>	26 <sup>0/-0.033</sup>	13	8	45	6	33	8 <sup>-0.01/-0.05</sup>	30	M8×1.25	15	30	M26×1.5	1/8	9	14
φ32	22	19.5	17	9	10	19	12 <sup>-0.01/-0.05</sup>	26 <sup>0/-0.033</sup>	13	8	45	6	37.5	10 <sup>-0.01/-0.05</sup>	30	M10×1.25	15	34.5	M26×1.5	1/8	9	14
φ40	24	21	22	10	15	30	16 <sup>-0.01/-0.05</sup>	32 <sup>0/-0.039</sup>	16	11	50	8	46.5	14 <sup>-0.01/-0.05</sup>	39	M14×1.5	21.5	42.5	M32×2	1/4	11	18

### Stroke Dimension Adder

(Unit : mm)

Stroke Symbol	1~50			51~100			101~150			151~200			201~250			
	Bore Size	LG	T	LT	LG	T	LT	LG	T	LT	LG	T	LT	LG	T	LT
φ20	87	158	167	112	183	192	137	208	217	—	—	—	—	—	—	—
φ25	87	162	171	112	187	196	137	212	221	—	—	—	—	—	—	—
φ32	89	164	173	114	189	198	139	214	223	164	239	248	—	—	—	—
φ40	113	202	213	138	227	238	163	252	263	188	277	288	213	302	313	—

ACP

APM

AS

AX

AM2

AM

AL

ALX

AQ

ADQ

AQ2

ADQ2

AJ

AJM

ABK

ACK1

NSK

AG

NGQ

AGX

GX

NP

ADR

AMR

NDM

ARD

NST

AST

ASTH

NLCD

NLCS

# Series AXKS(T)

## Rod Side Trunnion Type(U)

AXKU Bore Size Stroke  $\frac{S}{T}$

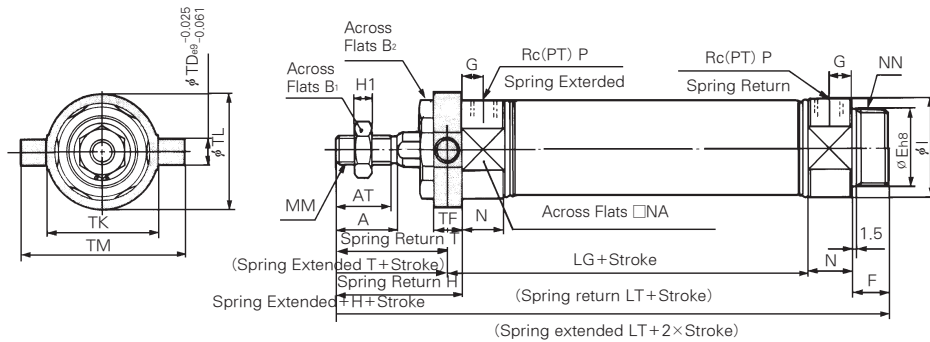

### Boss-cut type

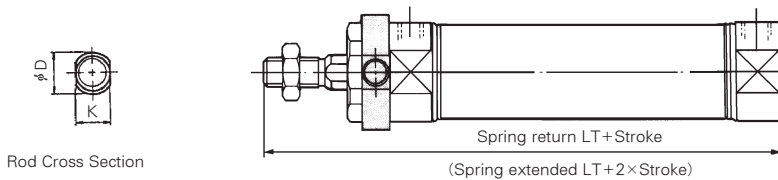

※ This drawing is spring extended

(mm)

Bore Size	A	AT	B <sub>1</sub>	B <sub>2</sub>	D	E	F	G	H	H <sub>1</sub>	I	K	MM	N	NA	NN	P	TD	TF	TK	TL	TM	T
φ20	18	15.5	13	26	10 <sup>-0.01/-0.05</sup>	20 <sup>0/-0.033</sup>	13	8	41	5	27	8 <sup>-0.01/-0.05</sup>	M8×1.25	15	24	M20×1.5	1/8	8	10	32	32	52	36
φ25	22	19.5	17	32	10 <sup>-0.01/-0.05</sup>	26 <sup>0/-0.033</sup>	13	8	45	6	33	8 <sup>-0.01/-0.05</sup>	M8×1.25	15	30	M26×1.5	1/8	9	10	40	40	60	40
φ32	22	19.5	17	32	12 <sup>-0.01/-0.05</sup>	26 <sup>0/-0.033</sup>	13	8	45	6	37.5	10 <sup>-0.01/-0.05</sup>	M10×1.25	15	34.5	M26×1.5	1/8	9	10	40	40	60	40
φ40	24	21	22	41	16 <sup>-0.01/-0.05</sup>	32 <sup>0/-0.039</sup>	16	11	50	8	46.5	14 <sup>-0.01/-0.05</sup>	M14×1.5	21.5	42.5	M32×2	1/4	10	11	53	53	77	44.5

### Stroke Dimension Adder

(mm)

Stroke Symbol	1~50		51~100		101~150		151~200		201~250	
	LG	LT	LG	LT	LG	LT	LG	LT	LG	LT
φ20	87	141	112	166	137	191	—	—	—	—
φ25	87	145	112	170	137	195	—	—	—	—
φ32	89	147	114	172	139	197	164	222	—	—
φ40	113	179	138	204	163	229	188	254	213	279

### Boss-Cut Type

(mm)

Stroke Symbol	1~50		51~100		101~150		151~200		201~250	
	LT	LT	LT	LT	LT	LT	LT	LT	LT	
φ20	128	153	178	—	—	—	—	—	—	
φ25	132	157	182	—	—	—	—	—	—	
φ32	134	159	184	209	—	—	—	—	—	
φ40	163	188	213	238	263	—	—	—	—	

# Series AXKS(T)

## Head Side Trunnion Type (T)

AXKT Bore Size Stroke  $\frac{S}{T}$

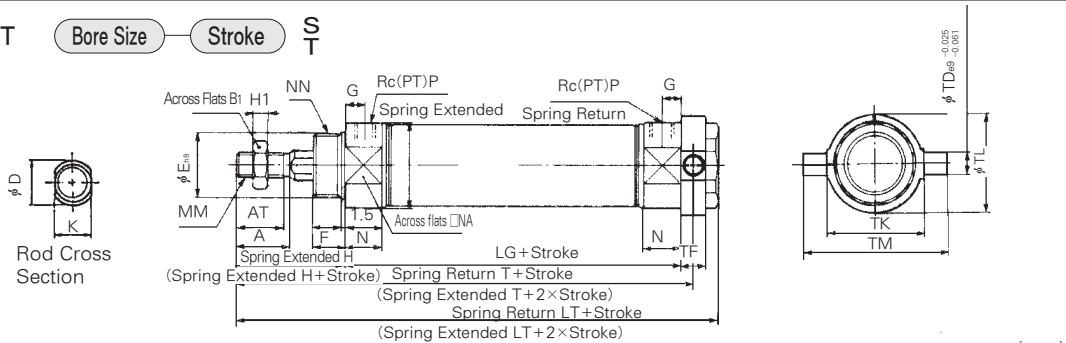

Bore Size	A	AT	B <sub>1</sub>	B <sub>2</sub>	D	E	F	G	H	H <sub>1</sub>	I	K	MM	N	NA	NN	P	TD	TF	TK	TL	TM
φ 20	18	15.5	13	26	10 <sup>-0.01/-0.05</sup>	20 <sup>0/-0.033</sup>	13	8	41	5	27	8 <sup>-0.01/-0.05</sup>	M8×1.25	15	24	M20×1.5	1/8	8	10	32	32	52
φ 25	22	19.5	17	32	10 <sup>-0.01/-0.05</sup>	26 <sup>0/-0.033</sup>	13	8	45	6	33	8 <sup>-0.01/-0.05</sup>	M8×1.25	15	30	M26×1.5	1/8	9	10	40	40	60
φ 32	22	19.5	17	32	12 <sup>-0.01/-0.05</sup>	26 <sup>0/-0.033</sup>	13	8	45	6	37.5	10 <sup>-0.01/-0.05</sup>	M10×1.25	15	34.5	M26×1.5	1/8	9	10	40	40	60
φ 40	24	21	22	41	16 <sup>-0.01/-0.05</sup>	32 <sup>0/-0.039</sup>	16	11	50	8	46.5	14 <sup>-0.01/-0.05</sup>	M14×1.5	21.5	42.5	M32×2	1/4	10	11	53	53	77

### Stroke Dimension Adder (mm)

Stroke Symbol	1~50			51~100			101~150			151~200			201~250		
	LG	T	LT	LG	T	LT	LG	T	LT	LG	T	LT	LG	T	LT
φ 20	87	133	143	112	158	168	137	183	193	-	-	-	-	-	-
φ 25	87	137	147	112	162	172	137	187	197	-	-	-	-	-	-
φ 32	89	139	149	114	164	174	139	189	199	164	214	224	-	-	-
φ 40	113	168.5	179	138	193.5	204	163	218.5	229	188	243.5	254	213	268.5	279

## Single Clevis Type (E)

AXKE Bore Size Stroke  $\frac{S}{T}$

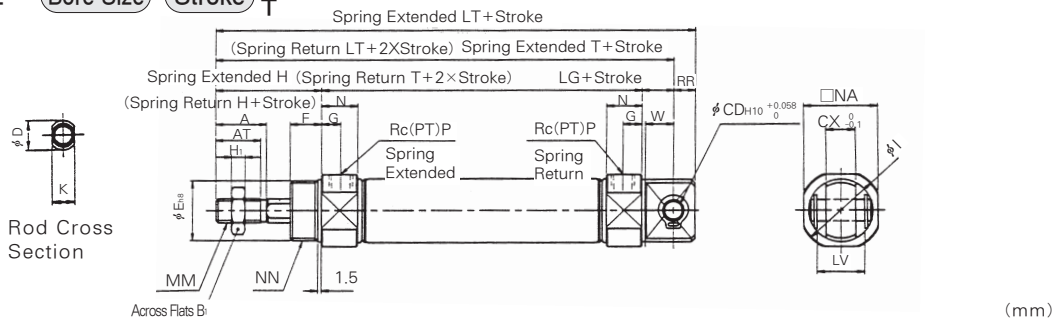

Bore Size	A	AT	B <sub>1</sub>	CD	CX	D	E	F	G	H	H <sub>1</sub>	I	K	L	LV	MM	N	NA	NN	P	RR	W
φ 20	18	15.5	13	8	12	10 <sup>-0.01/-0.05</sup>	20 <sup>0/-0.033</sup>	13	8	41	5	27	8 <sup>-0.01/-0.05</sup>	12	18.4	M8×1.25	15	24	M20×1.5	1/8	9	11.5
φ 25	22	19.5	17	8	12	10 <sup>-0.01/-0.05</sup>	26 <sup>0/-0.033</sup>	13	8	45	6	33	8 <sup>-0.01/-0.05</sup>	12	18.4	M8×1.25	15	30	M26×1.5	1/8	9	11.5
φ 32	22	19.5	17	10	20	12 <sup>-0.01/-0.05</sup>	26 <sup>0/-0.033</sup>	13	8	45	6	37.5	10 <sup>-0.01/-0.05</sup>	15	28	M10×1.25	15	34.5	M26×1.5	1/8	12	14.5
φ 40	24	21	22	10	20	16 <sup>-0.01/-0.05</sup>	32 <sup>0/-0.039</sup>	16	11	50	8	46.5	14 <sup>-0.01/-0.05</sup>	15	28	M14×1.5	21.5	42.5	M32×2	1/4	12	14.5

### Stroke Dimension Adder (mm)

Stroke Symbol	1~50			51~100			101~150			151~200			201~250		
	LG	T	LT	LG	T	LT	LG	T	LT	LG	T	LT	LG	T	LT
φ 20	87	140	149	112	165	174	137	190	199	-	-	-	-	-	-
φ 25	87	144	153	112	169	178	137	194	203	-	-	-	-	-	-
φ 32	89	149	161	114	174	186	139	199	211	164	224	236	-	-	-
φ 40	113	178	190	138	203	215	163	228	240	188	253	265	213	278	290

- ACP
- APM
- AS
- AX**
- AM2
- AM
- AL
- ALX
- AQ
- ADQ
- AQ2
- ADQ2
- AJ
- AJM
- ABK
- ACK1
- NSK
- AG
- NGQ
- AGX
- GX
- NP
- ADR
- AMR
- NDM
- ARD
- NST
- AST
- ASTH
- NLCD
- NLCS

# Series AXR

## Direct Mounting Cylinder/Double Acting Single Rod

Bore Size(mm) :  $\varnothing 20$ ,  $\varnothing 25$ ,  $\varnothing 32$ ,  $\varnothing 40$

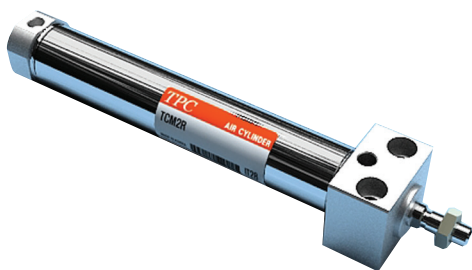

- STAINLESS STEEL BODY
- HIGH CYCLE LIFE
- LOW BREAKAWAY
- MAGNET STANDARD FOR AUTO SWITCH
- BUMPERS STANDARD
- DESIGNED FOR NON-LUBRICATED SERVICE
- COMPACT LIGHT DESIGN
- ADJUSTABLE STROKE AVAILABLE
- REPLACEABLE ROD GLAND

### Symbol

Double Acting / Single Rod

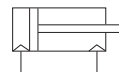

## How to Order

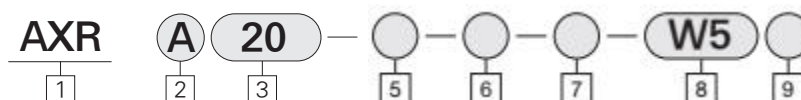

### 1 Direct Mount

### 2 Mounting

A : Rear Pivot Mounting  
B : Front Face Mounting

### 3 Bore Size(mm)

20 :  $\varnothing 20$   
25 :  $\varnothing 25$   
32 :  $\varnothing 32$   
40 :  $\varnothing 40$

### 4 Stroke/mm

$\varnothing 20$  : 25, 50, 75, 100, 125, 150  
 $\varnothing 25$  : 25, 50, 75, 100, 125, 150, 200  
 $\varnothing 32$  : 25, 50, 75, 100, 125, 150, 200  
 $\varnothing 40$  : 25, 50, 75, 100, 125, 150, 200, 250, 300

### 5 Cushion

Blank: Rubber Cushion  
A : Air Cushion

### 6 Rod end thread type

Blank: Rod end male thread  
F : Rod end female thread

### 7 Special Option

Blank: Standard Type  
XC16:Copper-Free

### 8 AutoSwitch (Band Mounted Type)

<Grommet>  
W5: Reed Switch, 0.5m Lead Wire  
W5L: Reed Switch, 3m Lead Wire

### 9 Number of Auto Switches

Blank : 2 pcs  
S : 1 pc  
N : N pcs

### PART No. of Auto Switch Mounting Band

Auto Switch Model	Bore size (mm)			
	$\varnothing 20$	$\varnothing 25$	$\varnothing 32$	$\varnothing 40$
W5	TBM2-020	TBM2-025	TBM2-032	TBM2-040

## Series AXR

- Using the square rod cover, it is preferred to install the AXR Series direct mounting cylinder.
- **Configuration with space saving**  
Its overall length is shorter, and its installation pitch can be made smaller since a directly mounted style can be possible without using brackets, so that the space needed for installation is significantly reduced.
- **Installation with enhanced accuracy and strength**  
The installation accuracy can be improved using a centering boss since it is the directly mounted style, and the strength has been increased.
- **Two different styles in installation**  
The installation may be provided with two styles and may be selected based on the purpose : Thus, the front mounting style or the bottom mounting style.

### Specifications

Action	Double Acting Single Rod
Fluid	Air
Proof Pressure	1.5MPa (213psi)
Max. Operating Pressure	1.0MPa (140psi)
Min. Operating Pressure	0.05MPa (7psi)
Ambient and Fluid Temperature	-50~158°F (-10°C~+70°C)
Lubricant	None(Non-Lube)
Stroke Tolerance	+ $\frac{1.4}{0}$ mm
Mounting	Flush Mounting, Front Face Mounting

### Piston Speed

Bore Size(mm)	φ 20	φ 25	φ 32	φ 40
Piston Speed(mm/sec)	50~750			
Allowable Kinetic Energy(kgf-cm)	2.7	4	6.5	12

### Auto Switch Specifications

Mounting	Lead Wire Entry	Reed Switch
Band Mounting Type	Grommet	W5

### Mounting and Accessories

Accessories	Standard	Option	
	Rod End Nut	Single Knuckle Joint	Double Knuckle Joint
Rear Pivot Mounting	○	○	○
Front Face Mounting	○	○	○

### Weight Table

kgf(lb)

Bore size(mm)		φ 20	φ 25	φ 32	φ 40
Basic Weight	Rear Pivot Mounting	0.14 (0.31)	0.24 (0.51)	0.33 (0.7)	0.62 (1.36)
	Front Face Mounting	0.14 (0.31)	0.22 (0.48)	0.33 (0.7)	0.61 (1.34)
Additional Weight For Each 50 mm of Stroke		0.04 (0.09)	0.06 (0.13)	0.08 (0.17)	0.14 (0.28)

#### Calculation Example : AXRA 32-100

• Basic weight ... 0.32kgf    • Additional weight ... 0.08/50 stroke    • Cylinder stroke ... 100 stroke  
 $0.32 + 0.08 \times 100/50 = 0.48$  kgf

ACP
APM
AS
<b>AX</b>
AM2
AM
AL ALX
AQ ADQ
AQ2 ADQ2
AJ AJM
ABK
ACK1
NSK
AG
NGQ
AGX GX
NP
ADR
AMR
NDM
ARD
NST
AST
ASTH
NLCD
NLCS

# Series AXR

## Construction/Parts List

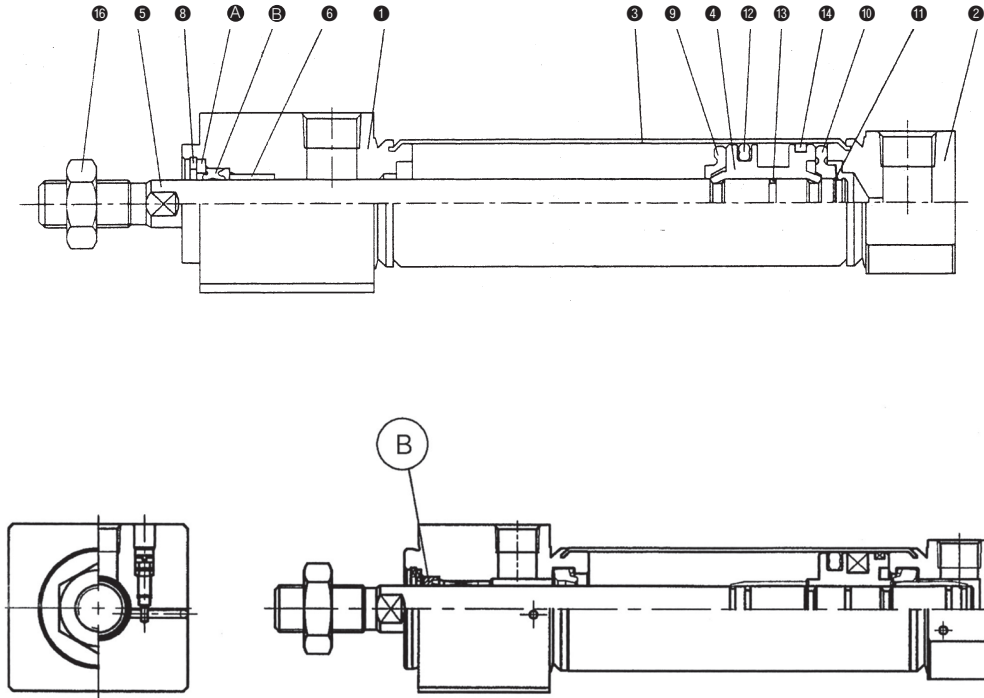

### Parts List

No.	Description	Material	Remarks
1	Rod Cover	Aluminum Alloy	White Alumite
2	Head Cover	Aluminum Alloy	White Alumite
3	Cylinder Tube	Stainless Steel	
4	Piston	Aluminum Alloy	Chromate
5	Piston Rod	Carbon Steel	Hard Chrome Plated
6	Bushing	Sintered BR	
A	Packing	NBR	Nickel Plated
8	Retaining Ring	Carbon Steel	Nickel Plated
9	Bumper A	Urethane	
10	Bumper B	Urethane	
11	Retaining Ring	Carbon Tool Steel	
12	Piston Packing	NBR	
13	Piston Packing	NBR	
14	Wear Ring		
16	Rod End Nut	Carbon Steel	Nickel Plated

### Packing List

Rubber Cushion / Air Cushion							
No.	Description	Material	Type	Bore Size			
				20	25	32	40
B	Rod Packing	NBR	Rubber Cushion	PDU-8LZ	PDU-10LZ	PDU-12LZ	PDU-14LZ
			Air Cushion	PDU-8Z	PDU-10Z	PDU-12Z	PDU-14Z

# Series AXR

## Rear Pilot Mounting

AXRA **Bore Size** — **Stroke**

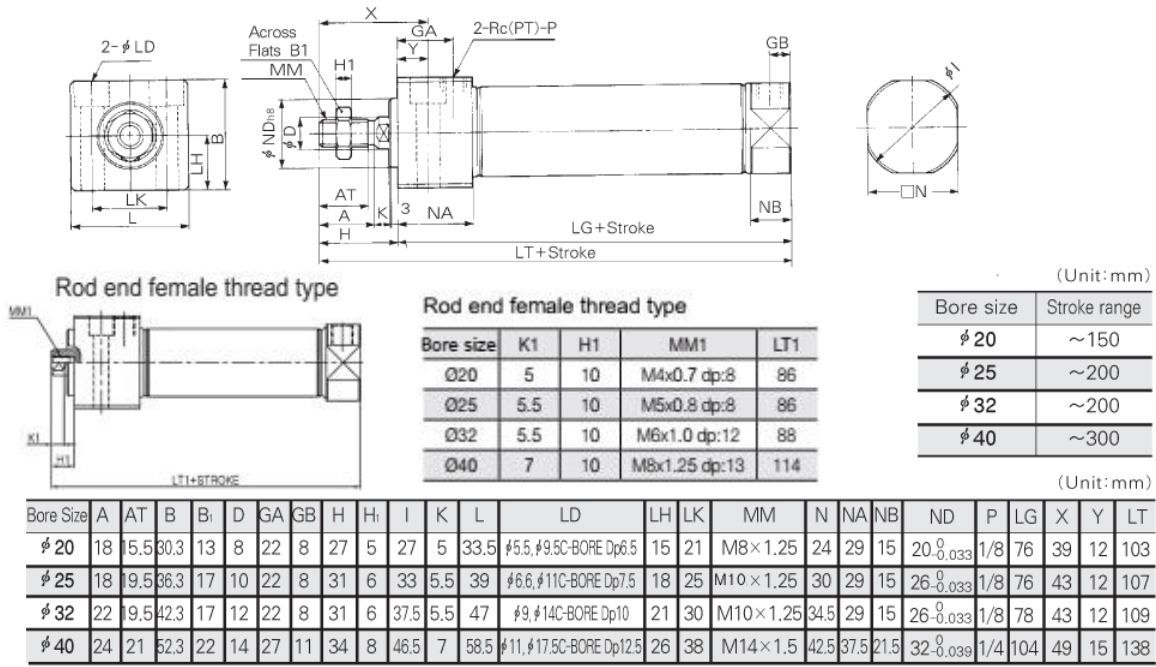

## Front Side Mounting

AXRB **Bore Size** — **Stroke**

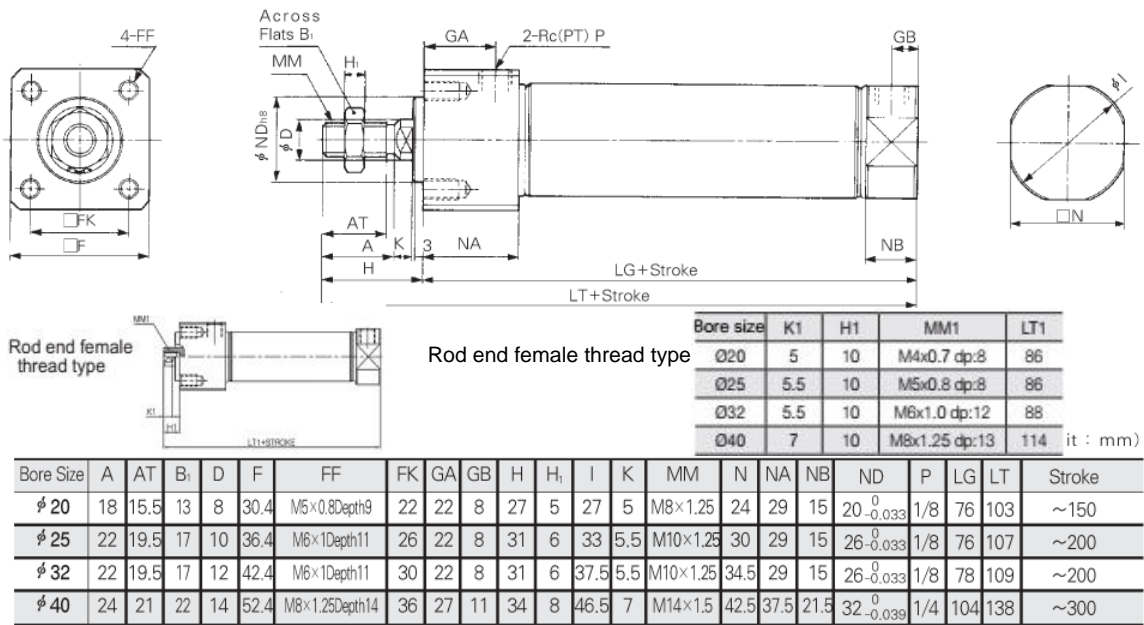

ACP

APM

AS

**AX**

AM2

AM

AL

ALX

AQ

ADQ

AQ2

ADQ2

AJ

AJM

ABK

ACK1

NSK

AG

NGQ

AGX

GX

NP

ADR

AMR

NDM

ARD

NST

AST

ASTH

NLCD

NLCS

# Series AXR

## ① Adjustable Stroke Cylinder/Extension Adjustable Type

AXR (Mounting) (Bore Size) (Stroke) (Stroke Adjusting Symbol) — XC8



### Stroke adjusting symbol

- A-Stroke Adjusting Range 0~25 mm
- B-Stroke Adjusting Range 0~50 mm

The extended stroke of the cylinder can be adjusted by the stopper on the head side from full stroke (0~25) mm or (0~50) mm.

## Specifications

Type	Air Cylinder
Applicable Bore Size	φ 20, φ 25, φ 32, φ 40
Action	Double Acting Single Rod
Piston Speed(mm/sec)	50~750
Cushion	Rubber Cushion(Standard)
Stroke Adjusting System	Stopper Adjustment
Stroke Adjusting Range	A:0~25 mm, B : 0~50 mm
Mounting	Rear Pivot Mounting, Front Nose Mounting

### Symbol

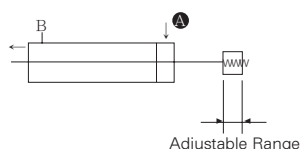

## Dimensions

### Rear Pilot Mounting

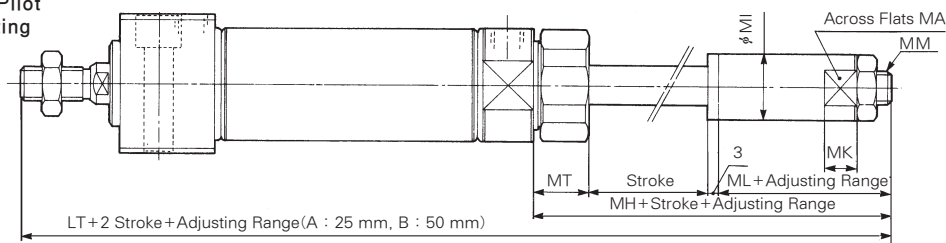

### Front Face Mounting

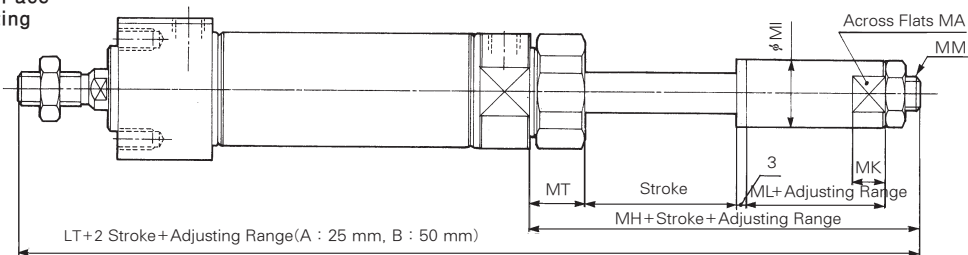

(mm)

Bore Size	MA	MH	MI	MK	ML	MM	MT	LT
φ 20	12	47	15	8	18	M8×1.25	16.5	150
φ 25	17	49	20	10	18	M8×1.25	17.5	156
φ 32	17	49	20	10	18	M10×1.25	17.5	158
φ 40	22	60	25	12	22	M14×1.5	21.5	198

※ Other dimensions are the same as for standard type.



## ② Adjustable Stroke Cylinder/Retraction Adjustable Type

AXR **Mounting** **Bore Size** **Stroke** **Stroke Adjusting Symbol** XC9



The retracted stroke of the cylinder can be adjusted from (0~25) mm or (0~50) mm by the adjusting bolt.

### Stroke Adjusting Symbol

- A-Stroke Adjusting Range 0~25 mm
- B-Stroke Adjusting Range 0~50 mm

### Specifications

Type	Air Cylinder
Applicable Bore Size	φ 20, φ 25, φ 32, φ 40
Action	Double Acting Single Rod
Piston Speed(mm/sec)	50~750
Cushion	Rubber Cushion(Standard)
Stroke Adjusting System	Stopper Adjustment
Stroke Adjusting Range	A:0~25 mm, B : 0~50 mm
Mounting	Rear Pivot Mounting, Front Nose Mounting

### Symbol

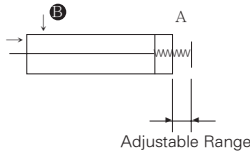

### Dimensions

#### Rear Pilot Mounting

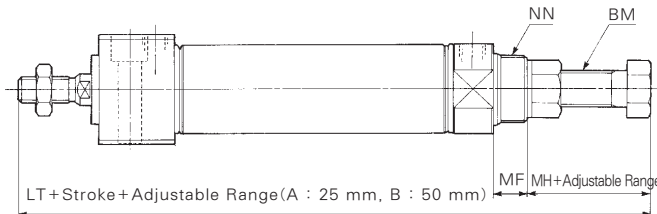

#### Front Face Mounting

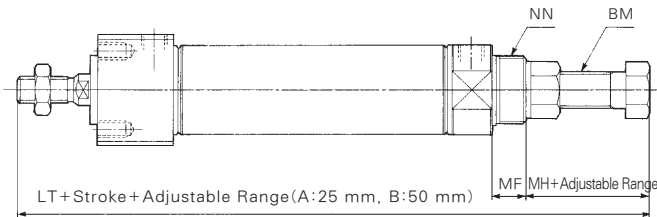

(Unit : mm)

Bore Size	BM	MF	MH	NN	LT
φ 20	M8×1.25	13	20	M20×1.5	136
φ 25	M8×1.25	13	20	M26×1.5	140
φ 32	M10×1.25	13	20	M26×1.5	142
φ 40	M12×1.75	16	24	M30×2	178

※ Other dimensions are the same for standard type.

ACP

APM

AS

**AX**

AM2

AM

AL  
ALX

AQ  
ADQ

AQ2  
ADQ2

AJ  
AJM

ABK

ACK1

NSK

AG

NGQ

AGX  
GX

NP

ADR

AMR

NDM

ARD

NST

AST

ASTH

NLCD

NLCS

# Series **AXRK**

## Non-Rotating Piston Rod Direct Mounting type

Bore Size(mm) : Ø20, Ø25, Ø32, Ø40



- DIRECT MOUNT CYLINDER
- HIGH ANTI-ROTATING ACCURACY
- SPACE SAVING CYLINDER
- SQUARE ROD COVER MAKES DIRECT MOUNTING POSSIBLE

Symbol

Double acting/Single rod  
Non-rotating Piston rod

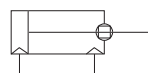

### How to Order

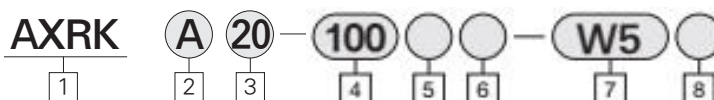

**1** Type  
Non-Rotating/  
Direct Pivot

**2** Mounting

A : Rear Pilot mounting  
B : Front side mounting

**3** Bore Size(mm)

20 : φ20  
25 : φ25  
32 : φ32  
40 : φ40

**4** Stroke(mm)

φ20 : 25, 50, 75, 100, 125, 150  
φ25 : 25, 50, 75, 100, 125, 150, 200  
φ32 : 25, 50, 75, 100, 125, 150, 200  
φ40 : 25, 50, 75, 100, 125, 150, 200,  
250, 300

**5** Rod end thread type

Blank : Rod end male thread  
F : Rod end female thread

**6** Special Option

Blank: Standard Type  
XC16:Copper-Free

**7** AutoSwitch  
(Band Mounted Type)

<Grommet>  
W5:Reed Switch, 0.5m Lead Wire  
W5L: Reed Switch, 3m Lead Wire

**8** Number of Auto Switches

Blank : 2 pcs  
S : 1 pc  
N : N pcs

#### PART No. of Auto Switch Mounting Band

Auto Switch Model	Bore size(mm)			
	20	25	32	40
W5	TBM2-020	TBM2-025	TBM2-032	TBM2-040

## Series AXRK

- **AXRK Series**
- **The Direct mounting of AXRK Series**  
 $\phi 20, \phi 25 - \pm 0.8^\circ$   
 $\phi 32, \phi 40 - \pm 0.5^\circ$
- **Accuracy with high non-rotation**  
 $f20, f25 - \pm 0.8^\circ$   
 $f32, f40 - \pm 0.5^\circ$
- **Configuration featuring space saving advantage**  
 Since a directly mounted style is adapted with no use of brackets, its entire length is shorter, and its installation pitch may be set smaller. So, the space required for installation is significantly reduced.
- **Enhanced accuracy and strength for installatin**  
 The installation accuracy is enhanced using a centering boss based on its directly mounted style, and the strength has also been enhanced.
- **Two different installation available**  
 Two different installations are available and selectable based on their purpose of use : the front mounting method or the bottom mounting method.

### Specifications

- Mounting Autoswitch : Existing Plug point



Front Face Mounting



Rear Pivot Mounting

- Calculation Example : AXRKA 32-100
- Basic Weight ... 0.32kgf
- Additional Weight ... 0.09kgf
- Cylinder stroke ... 100mm  
 $0.32 + 0.09 \times 100/50 = 0.50\text{kgf}$

### Specifications

Action	Double acting single rod
Fluid	Air
Proof Pressure	1.5MPa (213psi)
Max. Operating Pressure	1.0MPa (140psi)
Min. Operating Pressure	0.05MPa 7psi)
Ambient and Fluid Temperature	-10°C ~ +70°C (-50 ~ 153°F)
Cushion	Rubber Cushion (Standard)
Stroke Tolerance	+ $\delta^{1.4}$ mm
Non-Rotating Accuracy	$\phi 20, \phi 25: \pm 0.8^\circ, \phi 32, \phi 40: \pm 5^\circ$
Mounting	Rear Pivot Mounting, Front Face mounting

### Piston Speed

Bore Size(mm)	$\phi 20$	$\phi 25$	$\phi 32$	$\phi 40$
Piston Speed	50~500 mm/sec			
Allowable Kinetic Energy(kgf/cm)	2.7	4	6.5	12

### Auto Switch Specifications

Mounting	Lead Wire Entry	Reed Switch
Band Mounting Type	Grommet	W5

### Mounting and Accessories

Accessories	Standard	Option	
	Rod End Nut	Single Knuckle Joint	Double Knuckle Joint
Rear Pivot Mounting	○	○	○
Front Face Mounting	○	○	○

### Weight Table

kgf(lbf)

Bore Size(mm)		$\phi 20$	$\phi 25$	$\phi 32$	$\phi 40$
Basic Weight	Rear Pivot Mounting	0.14	0.24	0.33	0.63
	Front Face Mounting	0.14	0.23	0.32	0.62
Additional weight for each 50 of stroke		0.04	0.07	0.09	0.15

ACP

APM

AS

AX

AM2

AM

AL  
ALX

AQ  
ADQ

AQ2  
ADQ2

AJ  
AJM

ABK

ACK1

NSK

AG

NGQ

AGX  
GX

NP

ADR

AMR

NDM

ARD

NST

AST

ASTH

NLCD

NLCS

# Series AXRK

## Rear Pirot Mounting

AXRKA **Bore Size** **Stroke**

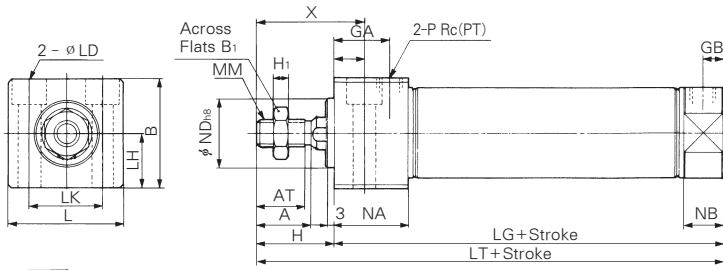

Rod Cross Section

Bore size	D	K	Stroke range
φ20	10 <sup>-0.01/-0.05</sup>	8 <sup>-0.01/-0.05</sup>	~150
φ25	10 <sup>-0.01/-0.05</sup>	8 <sup>-0.01/-0.05</sup>	~200
φ32	12 <sup>-0.01/-0.05</sup>	10 <sup>-0.01/-0.05</sup>	~200
φ40	16 <sup>-0.01/-0.05</sup>	14 <sup>-0.01/-0.05</sup>	~300

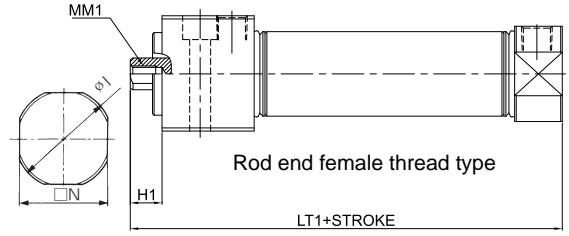

Rod end female thread type

Bore size	K <sub>1</sub>	H <sub>1</sub>	MM <sub>1</sub>	LT <sub>1</sub>
20	5	10	M4x0.7 dp:8	86
25	5.5	10	M5x0.8 dp:8	86
32	5.5	10	M6x1.0 dp:12	88
40	7	10	M8x1.25 dp:13	114

Bore size	A	AT	B	B <sub>1</sub>	GA	GB	H	H <sub>1</sub>	I	L	LD	LH	LK	MM	N	NA	NB	ND	P	LG	X	Y	LT
φ20	18	15.5	30.3	13	22	8	27	5	27	33.5	#6.5,#9.5C-BORE Dp6.5	15	21	M8×1.25	24	29	15	20 <sup>-0/-0.033</sup>	1/8	76	39	12	103
φ25	22	19.5	36.3	17	22	8	31	6	33	39	#6.6,#11C-BORE Dp7.5	18	25	M8×1.25	30	29	15	26 <sup>-0/-0.033</sup>	1/8	76	43	12	107
φ32	22	19.5	42.3	17	22	8	31	6	37.5	47	#9,#14C-BORE Dp10	21	30	M10×1.25	34.5	29	15	26 <sup>-0/-0.033</sup>	1/8	78	43	12	109
φ40	24	21	52.3	22	27	11	34	8	46.5	58.5	#11,#17.5C-BORE Dp12.5	26	38	M14×1.5	42.5	37.5	21.5	32 <sup>-0/-0.039</sup>	1/4	104	49	15	138

## Front Face Mounting

AXRKB **Bore Size** **Stroke**

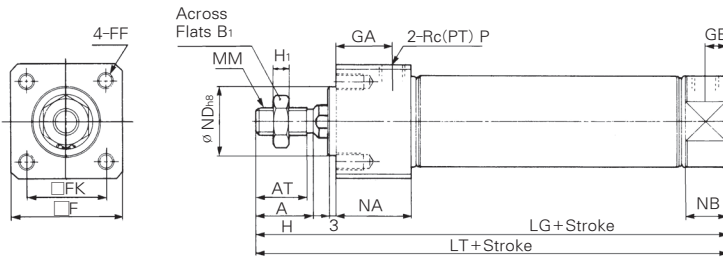

Rod Cross Section

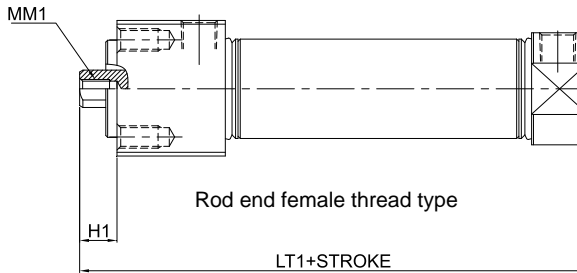

Rod end female thread type

Bore size	K <sub>1</sub>	H <sub>1</sub>	MM <sub>1</sub>	LT <sub>1</sub>
20	5	10	M4x0.7 dp:8	86
25	5.5	10	M5x0.8 dp:8	86
32	5.5	10	M6x1.0 dp:12	88
40	7	10	M8x1.25 dp:13	114

Bore size	A	AT	B <sub>1</sub>	F	FF	FK	GA	GB	H	H <sub>1</sub>	I	MM	N	NA	NB	ND	P	LG	LT	D	K	Stroke range
φ20	18	15.5	13	30.4	M5×0.8Dp9	22	22	8	27	5	27	M8×1.25	24	29	15	20 <sup>-0/-0.033</sup>	1/8	76	103	10 <sup>-0.01/-0.05</sup>	8 <sup>-0.01/-0.05</sup>	~150
φ25	22	19.5	17	36.4	M6×1Dp11	26	22	8	31	6	33	M8×1.25	30	29	15	26 <sup>-0/-0.033</sup>	1/8	76	107	10 <sup>-0.01/-0.05</sup>	8 <sup>-0.01/-0.05</sup>	~200
φ32	22	19.5	17	42.4	M6×1Dp11	30	22	8	31	6	37.5	M10×1.25	34.5	29	15	26 <sup>-0/-0.033</sup>	1/8	78	109	12 <sup>-0.01/-0.05</sup>	10 <sup>-0.01/-0.05</sup>	~200
φ40	24	21	22	52.4	M8×1.25Dp14	36	27	11	34	8	46.5	M14×1.5	42.5	37.5	21.5	32 <sup>-0/-0.039</sup>	1/4	104	138	16 <sup>-0.01/-0.05</sup>	14 <sup>-0.01/-0.05</sup>	~300

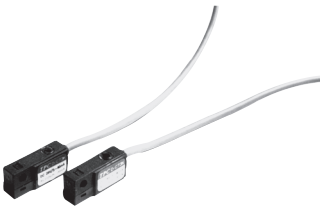

## Specifications W5 (With indicator lamp)

Auto Switch Model	W5	
Application	Relay, Sequence Control	
Load Voltage	DC24V	AC100V
Max. Load Current/Range of Load Current	5~40mA	5~20mA
Protection Circuit for Contact Breaker Point	None	
Internal Voltage Drop	2.4V or less	
Indicator Lamp	ON:Red light emitting diode	

- Leakage Current – None
  - Response Time – 1.2ms
  - Lead Wire – Oil proof vinyl,  $\phi$  3.4 0.2mm<sup>2</sup>, 2 Wire(red, black), 0.5m(18in)
  - Impact Resistance– 30G
  - Insulation Resistance – 50M $\Omega$  or more under the test voltage DC500V (Between case and cable)
  - Withstand Voltage – AC1500V 1min (between case and cable)
  - Ambient Temperature – 14~140°F (-10~60°C)
  - Protection Structure – IEC spec IP67, Water-proof(JISCO920), oil-proof.
- \* If 3m lead wire is required, L is put at the end of numbers.  
Example : W5L

## Auto Switch/Internal Circuit

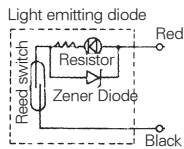

## Auto Switch Dimensions

(mm)

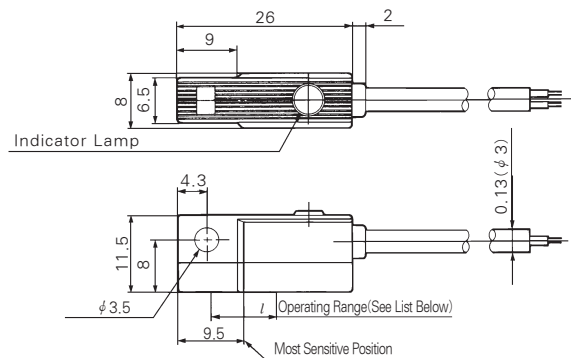

## Operating Range( l Dimension)

(mm)

Series	Bore size			
	$\phi$ 20	$\phi$ 25	$\phi$ 32	$\phi$ 40
AX	7	8	8	8

ACP

APM

AS

**AX**

AM2

AM

AL  
ALX

AQ  
ADQ

AQ2  
ADQ2

AJ  
AJM

ABK

ACK1

NSK

AG

NGQ

AGX  
GX

NP

ADR

AMR

NDM

ARD

NST

AST

ASTH

NLCD

NLCS